

A muscular man in a red tank top is performing a deadlift in a gym. He is leaning forward, gripping a barbell with weights. The gym background is filled with various pieces of equipment like racks and benches.

MATRIX

STRENGTH
2021 BROCHURE



CONTENTS

4 MATRIX FITNESS

*TOTAL SOLUTIONS PARTNER
STRONG. SMART. BEAUTIFUL.
STRENGTH OVERVIEW*

12 MATRIX CONNECTED SOLUTIONS

18 ULTRA SERIES

*THE ULTIMATE STRENGTH
TRAINING EXPERIENCE*

36 VERSA SERIES

*THE POWER OF CHOICE IN
STRENGTH TRAINING*

58 AURA SERIES

*THE STANDARD IN PERFORMANCE
AND DESIGN*

82 GO SERIES

DISCOVER THE STRENGTH OF SIMPLICITY

92 MAGNUM SERIES

*A LEGACY OF PERFORMANCE AND
PROVEN DURABILITY*

148 VARSITY SERIES

*DESIGNED FOR SUPERIOR VALUE
AND TRAINING VARIETY*

MORE THAN THE WORLD'S FINEST FITNESS EQUIPMENT

When you choose Matrix, you're getting more than the world's finest fitness equipment. You're getting a partner that will be there, for your grand opening and every day after. Together, there's no detail of your business that we can't refine, reimagine or reinvent. And that includes your bottom line.

FACILITY PLANNING

Your space. Your goals. Your budget. We'll help bring your fitness center to life from your earliest ideas to the day you open your doors.

CERTIFIED INSTALLATION/SERVICE KIT

Maximize uptime. Optimize your investment. We provide all the tools you need to get up and running and stay that way.

INDUSTRY-LEADING WARRANTIES

Our promise of quality to you. We offer all of the protection you need to choose confidently, and know that you've chosen the products with the lowest cost of ownership in the industry.

DEDICATED SALES SUPPORT

Our internal teams will work with you to help you reach your unique goals. We'll help you choose the ideal mix of products for your needs and work with you to update and expand as your needs change.

POST-INSTALL PRODUCT TRAINING

We'll give your team a full demonstration on how to use your new equipment, plus introduce exclusive programs like Sprint 8[®]. At the end of training, your team will have everything they need to show members how to use your new equipment to its fullest potential.

FINANCING*

Whenever possible, we work with our customers to develop financial solutions that expand their options and maximize their investments.

UNMATCHED CUSTOMER SUPPORT

A 95% first-time fix rate. A 90% live answer rate in two minutes or less. A 48-hour service response window. More than 250 service providers with over 600 technicians to serve you. And with our amazing console technology, we can provide diagnostic services remotely or on site.

MATRIX LEARNING

Product training. Maintenance tips. Career building. On-demand educational videos. A whole new world of service and support. It's all at your fingertips with Matrix Learning (matrixlearningcenter.com).

TOTAL MARKETING SUPPORT KIT

You want to let clients know about the exciting programs and products that make your facility different, and we want to help. Ask us about customized promotional materials to help you reach and retain clients like never before.

* Availability of financing options varies by market.

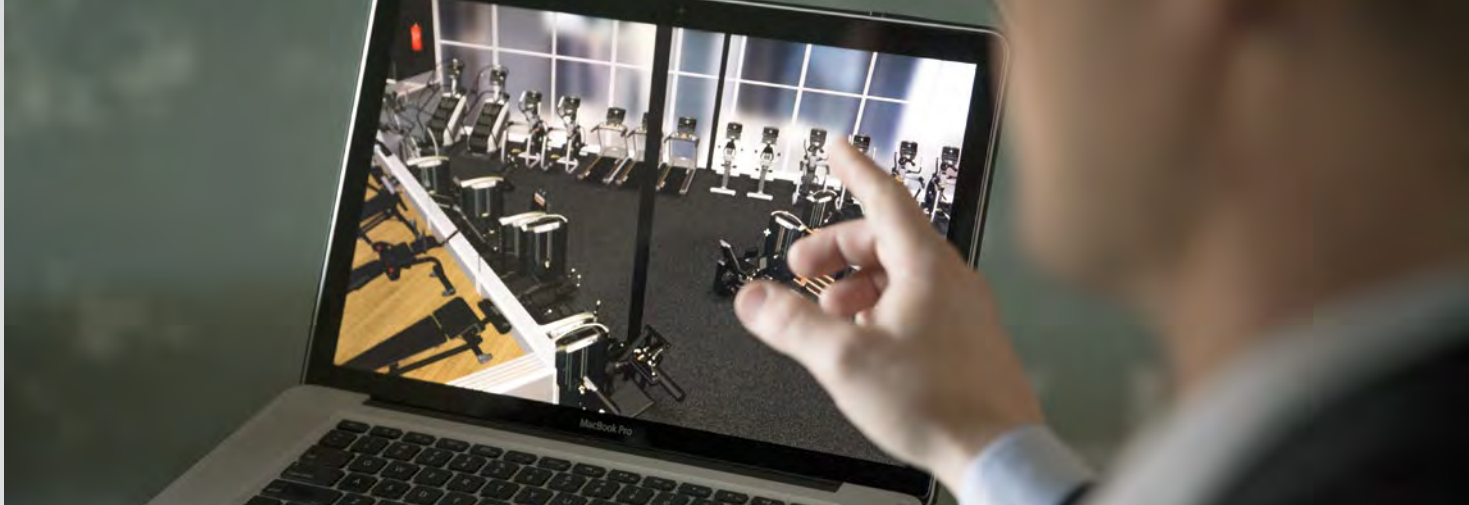

MATRIX SERVICE DIRECT APP

If you need to place service requests on the go, Matrix Service Direct makes it faster and more efficient. Our intuitive new app offers a guided experience that defines equipment issues, notifies Matrix, tracks live repair status, displays product repair history and more. Download Matrix Service Direct today to get started.



STRONG. SMART. BEAUTIFUL.™

It's more than a tagline. It's our holistic promise to you that these three qualities will shine through every product that hits your floor and define our ongoing partnership.

STRONG

Our high-quality, ultra-durable products are just as strong as our commitment to be your partner, not just your supplier. This strength gives us a solid foundation for success, today and in the future, and has made us one of the world's fastest-growing commercial fitness brands.

SMART

We listen and create products with a purpose in mind — to address your needs and resolve them in ingenious ways. Forward-thinking options like Asset Management™ and Virtual Active™ enhance and redefine the exercise experience, for both you and your members.

BEAUTIFUL

Our products attract beginners and fitness enthusiasts alike. Every piece of equipment is approachable, unintimidating and a pleasure to use. We continue to set new industry standards through award-winning aesthetic distinction and incredible attention to detail.



STRENGTH OVERVIEW

ULTRA SERIES /

Powerful yet comfortable. Advanced functionality with intuitive operation. The industry's most durable components wrapped in breathtaking industrial design. The Ultra Series goes beyond your expectations of strength training equipment to earn and retain members like nothing else.

VERSA SERIES /

Bring your vision of fitness to life — our most versatile series gives you the options to build a strength training area that fits your space and the needs of your members in a beautifully precise way. The Versa Series incorporates advanced biomechanics for a natural, smooth, efficient workout experience.

AURA SERIES /

Superior styling made the Aura Series an instant classic. Signature features made it one of the most-imitated product lines in the industry. Choose the Aura Series, and you'll discover that beginners and fitness enthusiasts alike will be drawn to something that the competition can't imitate — an unmistakable aura of greatness.



GO SERIES /

Now you can engage users new to strength training and circuit programs with our easy-to-use, space-efficient Go Series. Minimal adjustments, low starting weights, and smaller progressions create a welcoming experience where anyone can sit and go, while compact footprints, back-to-back designs, and low stack heights fit your space and budget.

MAGNUM SERIES /

Born from a long tradition of premium performance, there's no better choice for professional athletes than the unrivaled performance and durability of the Magnum Series. Advanced options like Breaker Benches and MEGA Racks help athletes reach their potential, and the impeccable designs stand up to the most demanding environments.

VARSITY SERIES /

For a blend of performance and value perfect for heavy-use facilities, look no further than the Varsity Series. It offers the dynamic performance and superior ergonomics that the fitness world has come to expect from Matrix, plus the uncompromising durability you need to accommodate a steady stream of users.



MATRIX CONNECTED SOLUTIONS /

GET CONNECTED TO A WORLD OF DIGITAL SOLUTIONS

You want to deliver an unmatched fitness experience, and Matrix Connected Solutions gives you the flexible tools you need to do it your way, regardless of the size of your facility or budget.

With the power of our robust, open platform at your fingertips, service and maintenance become hassle-free. Your trainers can connect and engage with members in new ways for better results and more referrals. Everyone who comes through your doors can instantly connect to their favorite music, entertainment and social networks. It's easier than ever to expand your marketing efforts and make your brand the center of each member's fit lifestyle. And that's just a taste of what Matrix Connected Solutions can do. Discover how our complete selection of hardware and software solutions can help bring your vision of fitness to life in bigger, bolder, brighter ways than ever before.

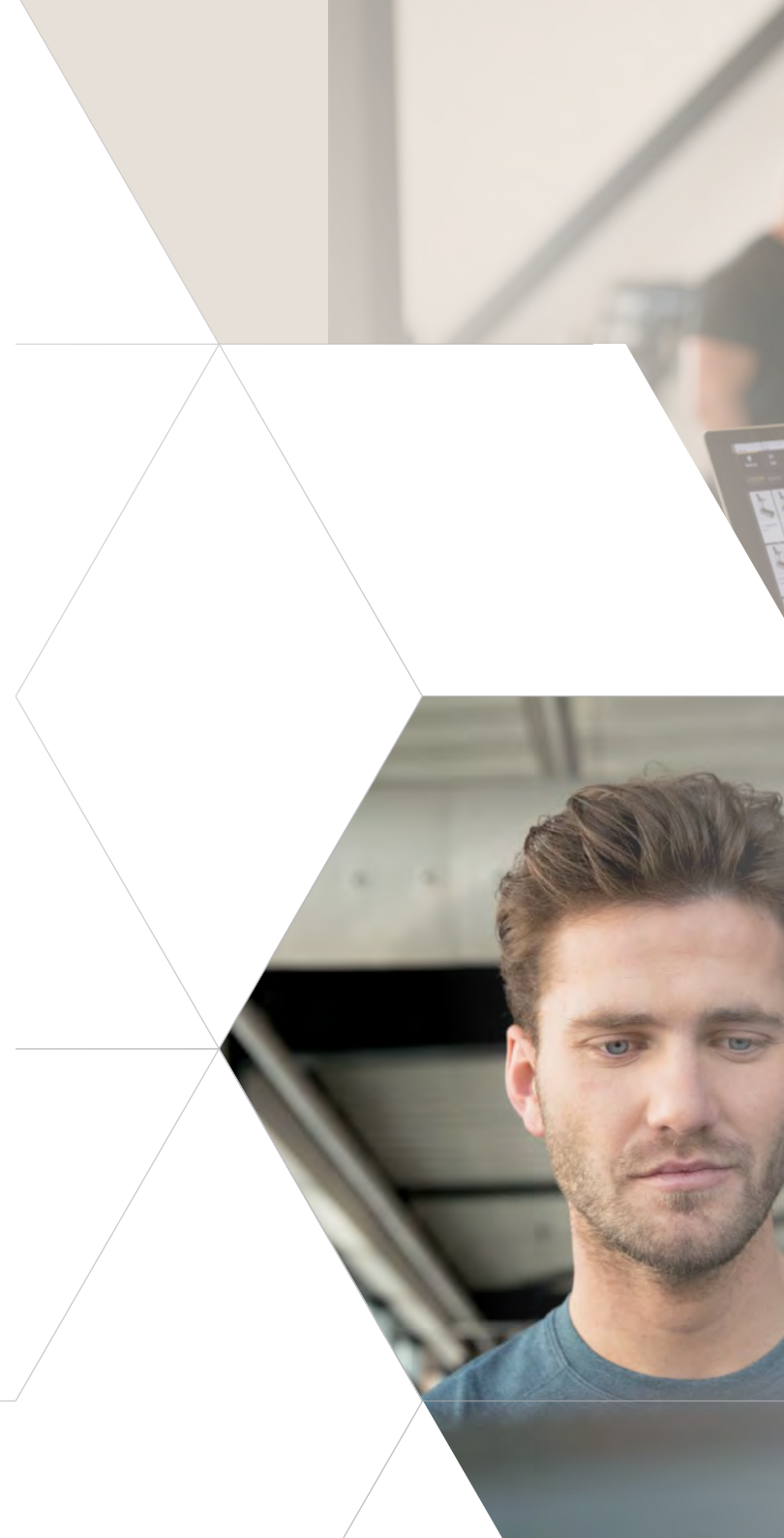



CONNECTED
SOLUTIONS

MATRIX CONNECTED SOLUTIONS /
YOUR GOALS

You have a vision of fitness that's all your own. The flexibility of our complete digital ecosystem lets you choose how you enhance your business, streamline your administrative tasks, impress the people you serve and much more.

INCREASE RETENTION

Bringing members back again is essential to the success of your business. With our smart digital options, they won't just come back — they'll bring friends.

BUILD ENGAGEMENT

Keep your members enthused, excited and eager for more with powerful tools that keep the exercise experience fresh.

BOOST REVENUE

Find out how to tap forward-thinking revenue streams that can redefine your bottom line in powerful new ways.

MAXIMIZE ROI

Count on us for smart tools that streamline the way you run your business while maximizing your investment and the value of every membership.

ENHANCE DIFFERENTIATION

Your facility is one of a kind, and our game-changing Connected Solutions can help you build your brand and stand out in impactful ways.

ENERGIZE ACQUISITION

You're always striving to bring in new members, and we can help extend your brand, reach untapped demographics and impress everyone who stops by.

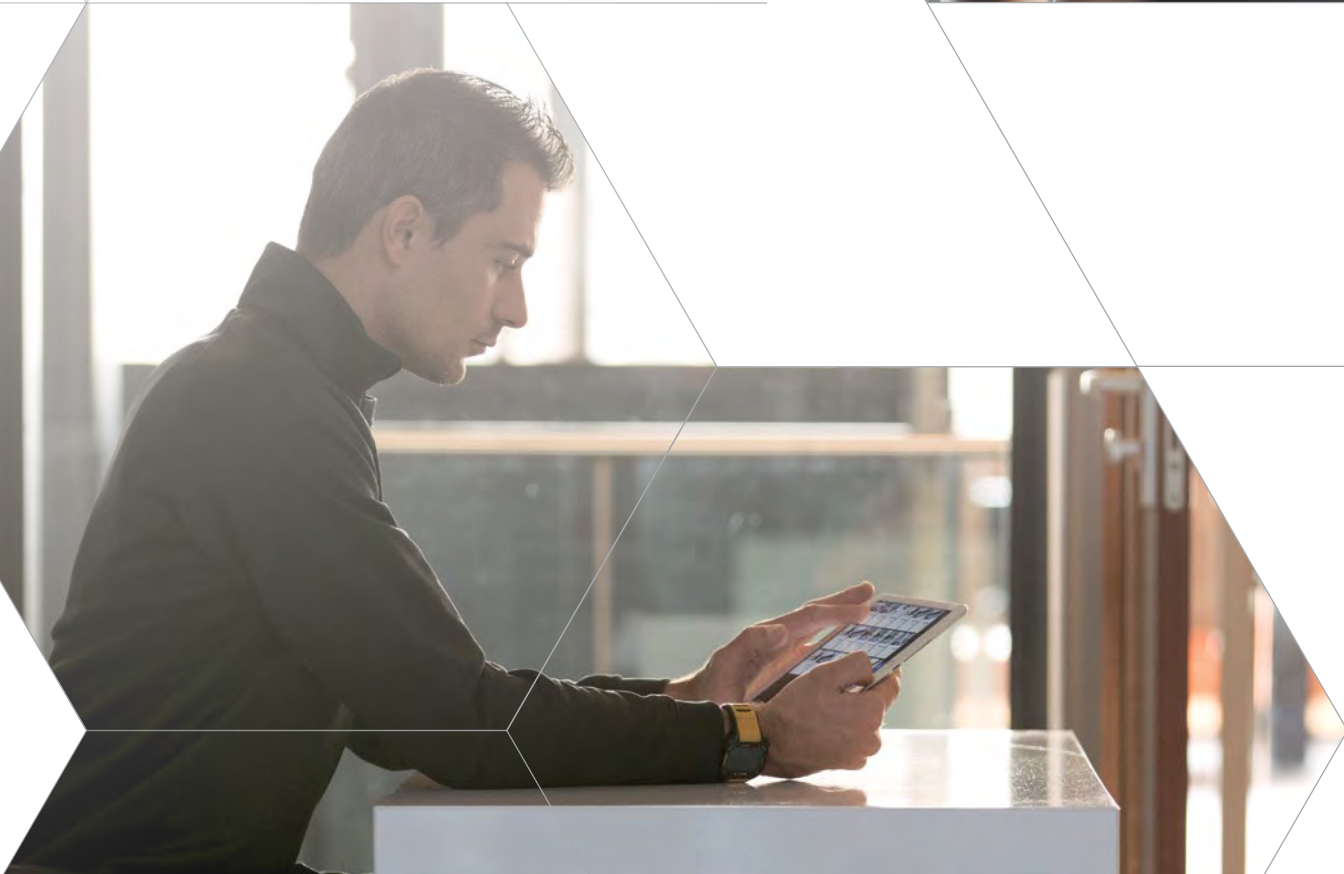

MATRIX CONNECTED SOLUTIONS /

INTELLIGENT TRAINING CONSOLE

Available exclusively on the latest Ultra Series equipment, Intelligent Training Console sets your facility apart with a digitally connected, guided strength training experience that will attract both new and experienced strength training enthusiasts and keep them coming back for more.

Your members will discover an intuitive interface that makes it easy for anyone to get started, plus dual user sign-in that streamlines transitions between two alternating users and their specific strength training programs. Since our original progression-based programming was designed in collaboration with the National Strength and Conditioning Association (NSCA), your members can count on measurable results. You can even customize the interface to strongly represent your brand, providing a unified look and feel throughout your entire facility.

Best of all, when you choose our Intelligent Training Console, you can take advantage of some of our most powerful Connected Solutions. This means that while your members are busy transforming their physiques, you'll be transforming the way you do business.



PERSONAL TRAINER PORTAL /
MAKE TRAINING MORE PERSONAL THAN EVER

Our flexible, customizable Personal Trainer Portal helps trainers engage with a wide range of clients, bringing personal training to a whole new demographic of members. Using virtually any tablet or personal computer, trainers can view member information, create signature strength programs, assign workouts and check progress, and members can provide instant feedback. Personal Trainer Portal works with a wide variety of popular third-party apps and wearables, and its customizable interface strongly represents your brand and your latest promotions.

WORKOUT TRACKING NETWORK
BRING IT ALL TOGETHER UNDER YOUR BRAND

Our ingenious Workout Tracking Network lets members capture data from all their favorite fitness apps and all the ways they work out in one place using a single customizable interface that puts your facility at the center of their fit lifestyle. Members can easily create personalized strength training goals, compete in challenges and applaud others through activity-based social feeds, and you can motivate members by offering reward points for check-ins, personal training, purchases and even personal bests.

ASSET MANAGEMENT /
**KEEPING AN EYE ON YOUR EQUIPMENT
SO YOU DON'T HAVE TO**

Our industry-leading Asset Management™ platform offers a 360-degree view of your strength training equipment on virtually any internet-connected device. Easy-to-read color-coding tells you whether a product is functioning properly, detects errors and alerts you if something is offline. Whether you manage one facility or many, the system can create customized reports to help maximize product life and identify the optimum product mix. It also improves communication with Matrix and your service provider, streamlining maintenance and repair while reducing paperwork and hassle. The customizable interface even provides an array of smart marketing tools to help you get more members into your facility.

RFID /
**STREAMLINE YOUR MEMBERS'
EXERCISE EXPERIENCE**

RFID is a smart way to streamline your members' strength training experience. Simple radio-frequency tags make check-in, program loading and workout tracking completely touch-free and virtually automatic. Members can even use RFID with your existing RFID-compatible vending machines, kiosks and in-facility sales centers for quick impulse buys of your branded merchandise, snacks, beverages and more.

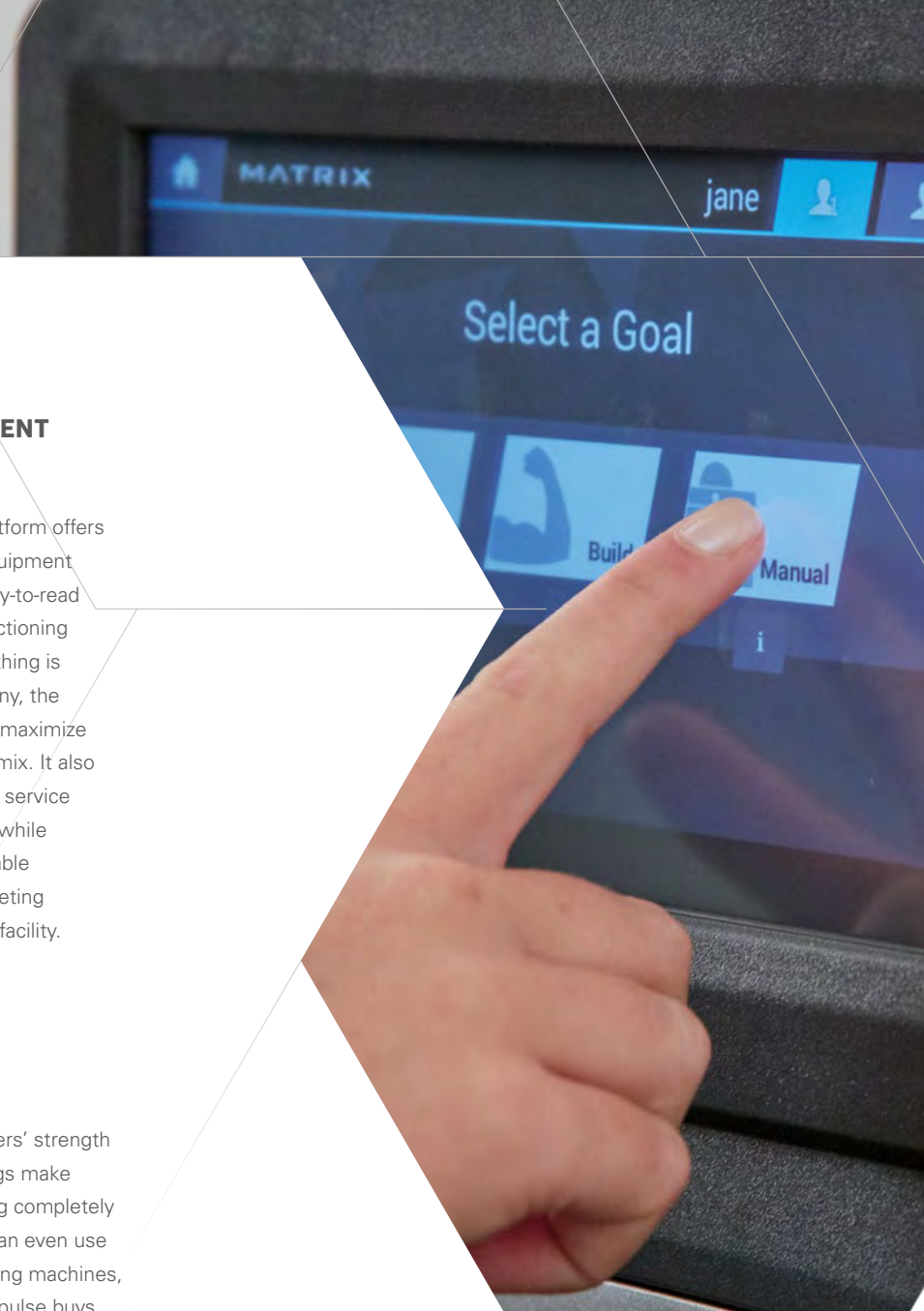

ULTRA SERIES /

THE ULTIMATE STRENGTH TRAINING EXPERIENCE



ULTRA SERIES /

The powerful and comfortable Ultra Series gives you the most advanced functionality with an intuitive design that couldn't be easier to operate. All Ultra Series equipment is designed for smooth converging and diverging movements to encourage a natural path of motion and enhance user comfort. Ultra Series also includes Action Specific Grips™ to reduce stress on contact points and a uniformly low stack height (122 cm / 48") to improve the aesthetic of your fitness center. Both durable and beautiful, the Ultra Series will exceed your expectations when it comes to earning and retaining members.



User Amenities All single-station units offer a convenient accessory pad, personal device holder and towel hook.
Incremental Weights Easy to access and reference from the seated position. **Electronic Rep Counter** Tracks reps, activity time and rest time for a streamlined workout experience. **Independent Converging/Diverging Motion** Encourages a natural path of motion to enhance comfort. **Exercise Placards** Easy-to-read reference cards highlight targeted muscle groups and proper machine use. **Action Specific Grips** Ergonomically designed to reduce stress on contact points while enhancing feel, function and form.

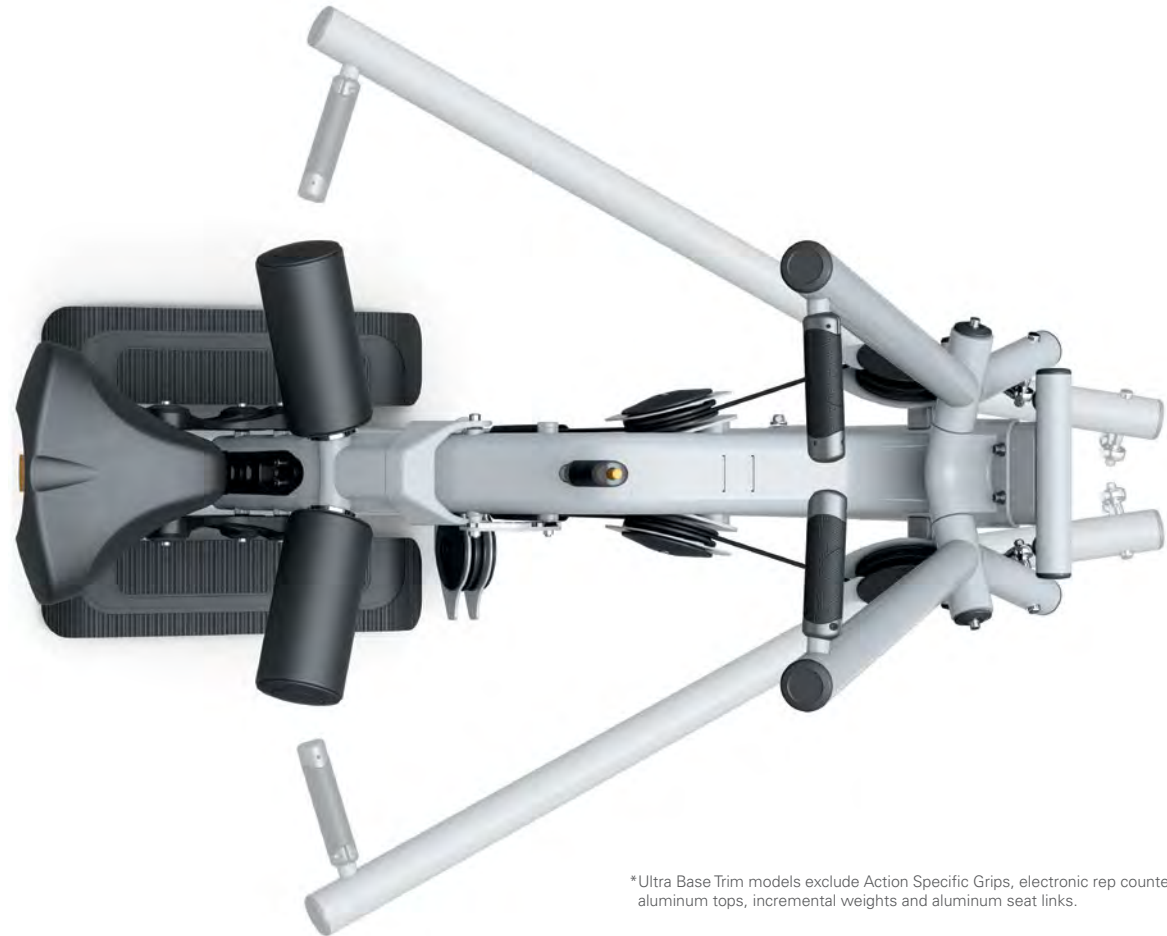

*Ultra Base Trim models exclude Action Specific Grips, electronic rep counters, aluminum tops, incremental weights and aluminum seat links.

ULTRA SERIES WITH INTELLIGENT TRAINING CONSOLE /

ULTRA: THE SMART CHOICE

Our powerful Ultra Series just got better and smarter with the addition of our new Intelligent Training Console. When you choose Ultra Series with Intelligent Training Console, you'll get a digitally connected, guided experience that will give those new to strength training a reason to sign up with your facility and those who already love it a reason to return. Members begin by defining their physical transformation target and receiving step-by-step equipment instruction. The intuitive interface makes it easy to identify their benchmark weight and start a personalized progression program. They'll also be able to review previous workouts to chart their development, helping them maximize their results and reach their individual goals more efficiently than ever.



A GUIDED TRAINING EXPERIENCE

Ideal for those new to strength training or experienced members who are struggling to progress, Intelligent Training Console features Endurance, Build and Strength programs to give members a guided training experience specific to their goals.

ORIGINAL PROGRESSIONS

Original progression-based programming designed in collaboration with the National Strength and Conditioning Association (NSCA) helps members find a benchmark weight and provides 8–12 weeks of workouts to maximize results.

EXPLOSIVE LIFTING

New explosive lifting program focuses on speed and power instead of just strength, helping members accelerate results while keeping the strength training experience fresh.

WORKOUT HISTORY

Workout history snapshot lets members quickly review past sessions and track overall progress.

DEMO VIDEOS

On-console demo videos provide guidance on maintaining proper form for each exercise.

INTUITIVE NAVIGATION

Intuitive touchscreen console navigation makes it easy for members of any ability or experience level to get started.

DUAL USER SIGN-IN

Dual user sign-in streamlines transitions between two alternating users and their specific strength training programs.

RECORDED SETTINGS

Stored seat settings make it easy for users to find the same ergonomically sound fit every time they work out.

TOUCH-FREE LOGIN

Included RFID capability gives users a quick, touch-free way to login, load their personal preferences and start their workout.

FULLY CONNECTED TECHNOLOGY

Internet connectivity via WiFi or ethernet provides access to included Asset Management and optional add-ons, such as Workout Tracking Network and Personal Trainer Portal.

BRAND-BUILDING CUSTOMIZATION

Customizable interface strongly represents your brand to provide a unified look and feel throughout your entire facility.

INTELLIGENT TRAINING CONSOLE SPECIFICATIONS

CONSOLE	
Display Type	25.7 cm / 10.1" touchscreen LCD
Display Feedback	Reps, sets, rest time, heart rate, total weight
Workouts	Manual, endurance, build, strength*, explosive lifts*
User-defined Multi-language Display	English, German, French, Italian, Spanish, Dutch, Portuguese, Chinese-S, Chinese-T, Japanese, Korean, Swedish, Finnish, Russian, Arabic, Turkish, Polish, Welsh, Basque, Vietnamese, Somali, Danish, Malaysian, Catalan, Thai
Lift to Start	Yes
Ethernet	Yes
WiFi	Yes
Bluetooth	Yes; heart rate
USB Port	Software updates only
RFID Wireless Login	Yes
TECH SPECS	
Power Requirements	120v / 60Hz AC power
Assembled Dimensions	153 cm / 60.2" (As assembled on the Ultra weight stack)
Shipping Dimensions	43.5 x 39.5 x 22 cm / 17.1" x 15.6" x 8.7"
Shipping Weight	78 kg / 172 lbs.

* Workout program only available on certain modalities



CONVERGING CHEST PRESS

Independent converging movement provides a natural path of motion • Adjustable back pad with gas assist facilitates easy range of motion changes • Integrated foot platform provides additional user stability and comfort during use • Designed for easy entry and exit • Available as Ultra Base Trim G7-S21B and Ultra Base Trim Heavy Stack G7-S21BH

	PRODUCT DIMENSIONS (L X W X H)						PRODUCT WEIGHT		WEIGHT STACK	
	CM		INCHES				KG	LBS	KG	LBS
G7-S13	168.5	141	135	66.3	55.4	53	348	768	108	240



LATERAL RAISE

Oversized arm pads enhance comfort and accommodate a variety of users • Rotating handles provide natural motion • Available as Ultra Base Trim G7-S21B and Ultra Base Trim Heavy Stack G7-S21BH

	PRODUCT DIMENSIONS (L X W X H)						PRODUCT WEIGHT		WEIGHT STACK	
	CM		INCHES				KG	LBS	KG	LBS
G7-S21	105.5	150	135	41.5	59	53	281	620	90	200



PEC FLY / REAR DELT

Rotating grips provide comfort and smooth movement during use • Angled back pad and delt grips enhance user comfort and improve biomechanics • Oversized handles reduce the need to adjust the seat position between rear deltoid and fly exercises • Heavy weight stack accommodates advanced users • Available as Ultra Base Trim G7-S22B and Ultra Base Trim Heavy Stack G7-S22BH

	PRODUCT DIMENSIONS (L X W X H)						PRODUCT WEIGHT		WEIGHT STACK	
	CM		INCHES				KG	LBS	KG	LBS
G7-S22	143.5	193.5	197	56.4	76.1	77.6	329	726	135	300



CONVERGING SHOULDER PRESS

Independent converging movement provides a natural path of motion • Dual-position hand grips allow for greater training variety • Counterbalanced pressing arms provide reduced starting resistance • Reclining seat position allows for better posture and back support • Available as Ultra Base Trim G7-S23B and Ultra Base Trim Heavy Stack G7-S23BH

	PRODUCT DIMENSIONS (L X W X H)						PRODUCT WEIGHT		WEIGHT STACK	
	CM		INCHES				KG	LBS	KG	LBS
G7-S23	168	146.5	174	66.1	57.6	68.4	359	792	90	200



DIVERGING LAT PULLDOWN

Independent diverging movement provides a natural path of motion • Angled seat encourages proper user position • Thigh pads and seat easily adjust to provide stability, comfort and improved ergonomics • Available as Ultra Base Trim G7-S33B and Ultra Base Trim Heavy Stack G7-S33BH

	PRODUCT DIMENSIONS (L X W X H)						PRODUCT WEIGHT		WEIGHT STACK	
	CM		INCHES				KG	LBS	KG	LBS
G7-S33	152	161	195	59.6	63.1	76.7	382	842	108	240



DIVERGING SEATED ROW

Independent diverging movement provides a natural path of motion • Dual-position foot placement provide greater user comfort • Adjustable chest pad with gas shock accommodates a variety of users • Available as Ultra Base Trim G7-S34B and Ultra Base Trim Heavy Stack G7-S34BH

	PRODUCT DIMENSIONS (L X W X H)						PRODUCT WEIGHT		WEIGHT STACK	
	CM		INCHES				KG	LBS	KG	LBS
G7-S34	158	138.5	140.5	62.2	54.5	55.3	343	757	108	240



INDEPENDENT BICEPS CURL

Unique pivoting elbow pads and rotating handles improve function, comfort and feel during use • Designed for easy entry and exit without chest compression from traditional machines • Elbow pad wear covers improve upholstery performance in high contact areas • Available as Ultra Base Trim G7-S40B and Ultra Base Trim Heavy Stack G7-S40BH

	PRODUCT DIMENSIONS (L X W X H)						PRODUCT WEIGHT		WEIGHT STACK	
	CM		INCHES				KG	LBS	KG	LBS
G7-S40	135	168	135	53	66.2	53	266	587	90	200



TRICEPS PRESS

Oversized rotating handles adapt to a wide variety of users and provide exercise variation • Angled back pad reduces stress, improves stabilization and enhances comfort • Available as Ultra Base Trim G7-S42B and Ultra Base Trim Heavy Stack G7-S42BH

	PRODUCT DIMENSIONS (L X W X H)						PRODUCT WEIGHT		WEIGHT STACK	
	CM		INCHES				KG	LBS	KG	LBS
G7-S42	124	121	135	48.8	47.7	53	305	673	120	265



ABDOMINAL CRUNCH

Curved back pads for full muscular contraction and comfort • Self-aligning handles adjust to accommodate a variety of users • Dual-supported pivoting design fosters natural abdominal crunch motion • Elbow pad wear covers improve upholstery performance in high contact areas • Available as Ultra Base Trim G7-S51B and Ultra Base Trim Heavy Stack G7-S51BH

	PRODUCT DIMENSIONS (L X W X H)						PRODUCT WEIGHT		WEIGHT STACK	
	CM	INCHES		KG	LBS	KG	LBS	KG	LBS	
G7-S51	139	121	147	54.6	47.5	57.9	290	640	108	240



BACK EXTENSION

Multi-position foot placement accommodates a variety of users • Thumb-switch controls allow easy adjustments • Contoured back pad enhances user comfort and provides additional support • Available as Ultra Base Trim G7-S52B and Ultra Base Trim Heavy Stack G7-S52BH

	PRODUCT DIMENSIONS (L X W X H)						PRODUCT WEIGHT		WEIGHT STACK	
	CM	INCHES		KG	LBS	KG	LBS	KG	LBS	
G7-S52	145	120	135	57.2	47.3	53	319	704	108	240



ROTARY TORSO

Kneeling position minimizes low-back stress while stretching hip flexors • Contoured knee pads with wear covers enhance comfort, stability and durability • Oversized handlebars accommodate a variety of users without adjustment • Knee pad wear cover improves upholstery performance in high contact areas • Range of motion feature with 8 different start positions adds greater versatility • Available as Ultra Base Trim G7-S55B and Ultra Base Trim Heavy Stack G7-S55BH

	PRODUCT DIMENSIONS (L X W X H)						PRODUCT WEIGHT		WEIGHT STACK	
	CM	INCHES		KG	LBS	KG	LBS	KG	LBS	
G7-S55	117	123	141	45.8	48.2	55.2	232	512	90	200



LEG PRESS

Angled and adjustable seat carriage enhances comfort • Ergonomic adjustment handle and gas shock enable simple changes in start position • Oversized foot platform increases movement variety including calf exercises • Integrated assistance handle enables easy exit and entry • Guide rod and bearing-designed carriage improves long-term durability and smooth performance • Available as Ultra Base Trim G7-S70B and Ultra Base Trim Heavy Stack G7-S70BH

	PRODUCT DIMENSIONS (L X W X H)						PRODUCT WEIGHT		WEIGHT STACK	
	CM	INCHES		KG	LBS	KG	LBS			
G7-S70	206	113	152	80.9	44.3	59.9	436	962	180	400





LEG EXTENSION

Self-adjusting tibia pad for greater ease of use • Soft contoured knee pad provides optimal comfort behind user's knee during use • Thumb-switch controls and ergonomic adjustment handle allow easy user setup • Angled seat and back pads encourage full quadriceps contraction • Pivot location clearly marked to encourage correct knee alignment • Available as Ultra Base Trim G7-S71B and Ultra Base Trim Heavy Stack G7-S71BH

	PRODUCT DIMENSIONS (L X W X H)						PRODUCT WEIGHT		WEIGHT STACK	
	CM		INCHES				KG	LBS	KG	LBS
G7-S71	152.4	125.9	135	60	49.6	53	304	671	108	240



SEATED LEG CURL

Back pad, tibia pad and range-of-motion adjustments are easily accessible from a seated position • Angled seat and unique pivot location encourage full hamstring contraction • Gas-assisted adjustable thigh pad and thumb switch control allow easy user setup • Soft contoured thigh pad provides optimal comfort during use • Available as Ultra Base Trim G7-S72B and Ultra Base Trim Heavy Stack G7-S72BH

	PRODUCT DIMENSIONS (L X W X H)						PRODUCT WEIGHT		WEIGHT STACK	
	CM		INCHES				KG	LBS	KG	LBS
G7-S72	148.5	117	135	58.4	46	53	320	706	90	200



PRONE LEG CURL

Contoured elbow pads enhance stabilization and comfort • Divergent pad angle eliminates lower-back stress • Integrated sweat guard protects frame from damage • Thumb-switch controls allow easy adjustments • Available as Ultra Base Trim G7-S73B and Ultra Base Trim Heavy Stack G7-S73BH

	PRODUCT DIMENSIONS (L X W X H)						PRODUCT WEIGHT		WEIGHT STACK	
	CM		INCHES				KG	LBS	KG	LBS
G7-S73	173	112	135	68	44	53	280	618	90	200



HIP ADDUCTOR

Ergonomic adjustment handle enables simple changes in start position • Foot pegs and contoured knee pads provide user stabilization and support • Adjustable reclining position offers customized lumbar comfort • Integrated foot platform allows easy exit and entry • Available as Ultra Base Trim G7-S74B and Ultra Base Trim Heavy Stack G7-S74BH

	PRODUCT DIMENSIONS (L X W X H)						PRODUCT WEIGHT		WEIGHT STACK	
	CM		INCHES				KG	LBS	KG	LBS
G7-S74	182	173	135	71.6	67.8	53	272	600	90	200



HIP ABDUCTOR

Ergonomic adjustment handle enables simple changes in start position • Foot pegs and contoured knee pads provide user stabilization and support • Adjustable reclining position offers customized lumbar comfort • Integrated foot platform allows easy exit and entry • Available as Ultra Base Trim G7-S75B and Ultra Base Trim Heavy Stack G7-S75BH

	PRODUCT DIMENSIONS (L X W X H)						PRODUCT WEIGHT		WEIGHT STACK	
	CM		INCHES				KG	LBS	KG	LBS
G7-S75	182	173	135	71.6	68	53	277	611	90	200



CALF EXTENSION

Angled seat position provides greater lumbar support • Ergonomic adjustment handle enables simple changes in start position • Range-of-motion adjustment accommodates a variety of users and start positions • Guide rod and bearing-designed carriage improves long-term durability and smooth performance • Available as Ultra Base Trim G7-S77B and Ultra Base Trim Heavy Stack G7-S77BH

	PRODUCT DIMENSIONS (L X W X H)						PRODUCT WEIGHT		WEIGHT STACK	
	CM		INCHES				KG	LBS	KG	LBS
G7-S77	169	120	150	66.5	47.2	59	291	642	180	400



GLUTE

Upright user position increases comfort and machine approachability • Rotating foot pad provides stable and smooth contact throughout the full range of motion • Oversized foot platform bolsters stability • Adjustable chest pad accommodates a variety of users • Available as Ultra Base Trim G7-S78B and Ultra Base Trim Heavy Stack G7-S78BH

	PRODUCT DIMENSIONS (L X W X H)						PRODUCT WEIGHT		WEIGHT STACK	
	CM	INCHES		KG	LBS	KG	LBS			
G7-S78	200.5	90	156	79	35.3	61.5	239	527	63	140



ULTRA STANDARD FRAME COLORS



Iced Silver†



Black Glossy



Matte Black



Lace White



Polarized Titanium

ULTRA UPHOLSTERY COLOR OPTIONS



Black

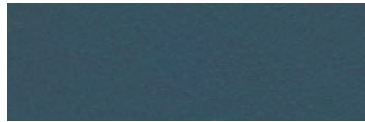

Slate Blue



Clay Red



Graphite



Alloy

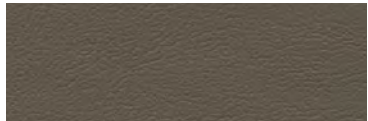

Hazelnut



Alloy / Graphite

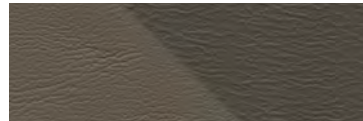

Hazelnut / Alloy



American Beauty



Candy Apple



New Burgundy



Paprika



Nasturtium



Mandarin Orange



Sun Yellow



Marigold



Emerald



Hunter Green



Royal Blue



Bluejay



New Purple



Navy



Bucksuede



Allspice



Cadet

Frame and upholstery colors applicable to the USA. Product pricing is reflective of **standard** upholstery only. Other color options available at an additional charge.
 NOTE: Actual product colors may vary from what is shown here. † Iced Silver is stocked frame color. Additional lead times may apply for other frame colors



VERSA SERIES /

THE POWER OF CHOICE IN STRENGTH TRAINING



VERSA SERIES /

The Versa Series offers a wide range of options — like standard or heavy weight stacks and optional foot support kits — so you can assemble a collection just right for your space, members and budget. Count on the Versa Series for a mix of advanced biomechanics and smart options that will bring your vision of fitness to life.



Exercise Placards Easy-to-read reference cards highlight targeted muscle groups and proper machine use. **Converging/Diverging Motion** Encourages a natural path of motion to enhance comfort. **Incremental Weights** Easy to access and reference from the seated position. **Action Specific Grips™** Ergonomically designed to reduce stress on contact points while enhancing feel and form (Versa+ package). **Electronic Rep Counter** Tracks reps, activity time and rest time for a streamlined workout experience (Versa+ package). **Gas-assisted Seat Adjustment** Offers smooth, instant adjustment, with a 4-bar linkage for increased stability (Versa+ package).

VERSA OPTIONS

VERSA+

(shown throughout brochure)

Comes with:

- Action Specific Grips
- Gas-assisted Seat Adjustment
- Electronic Rep Counter/Timer
- Decorative Top Wing
- Ergonomic Adjustment Handles
- Heavy Weight Stack
- Incremental Weight

WEIGHT STACK

- Choose between Standard and Heavy Weight Stack

OPTIONAL FOOT SUPPORT KIT

Available on:

- Converging Chest Press
- Converging Shoulder Press
- Biceps Curl
- Back Extension





CONVERGING CHEST PRESS

Independent converging movement provides a natural path of motion • Designed for easy entry and exit • Adjustable start position facilitates increased range of motion

	PRODUCT DIMENSIONS (L X W X H)						PRODUCT WEIGHT		WEIGHT STACK	
	CM		INCHES				KG	LBS	KG	LBS
VS-S13	139.3	134.7	160.8	54.9	53	63.3	230	508	72.6	160
VS-S13P	139.3	134.7	167.1	54.9	53	65.8	265	584	104	230
VS-S13H	139.3	134.7	160.8	54.9	53	63.3	262	578	104	230



CONVERGING SHOULDER PRESS

Independent converging movement provides a natural path of motion • Dual-position hand grips allow for greater training variety • Counterbalanced pressing arms provide reduced starting resistance

	PRODUCT DIMENSIONS (L X W X H)						PRODUCT WEIGHT		WEIGHT STACK	
	CM		INCHES				KG	LBS	KG	LBS
VS-S23	171	143.7	203.6	67.3	56.6	80.1	245	538	72.6	160
VS-S23P	171	143.7	203.6	67.3	56.6	80.1	279	614	104	230
VS-S23H	171	143.7	203.6	67.3	56.6	80.1	276	608	104	230



DIVERGING LAT PULLDOWN

Independent diverging movement provides a natural path of motion • Angled seat encourages proper user position • Thigh pad easily adjusts for stability and comfort

	PRODUCT DIMENSIONS (L X W X H)						PRODUCT WEIGHT		WEIGHT STACK	
	CM		INCHES				KG	LBS	KG	LBS
VS-S33	155.4	150.1	187.9	61.2	59.1	74	292	642	72.6	160
VS-S33P	155.4	150.1	187.9	61.2	59.1	74	334	735	104	230
VS-S33H	155.4	150.1	187.9	61.2	59.1	74	331	729	104	230



DIVERGING SEATED ROW

Independent cable movement provides a user-defined path of motion and exercise variety • Adjustable chest pad accommodates users of all sizes • Rotating grips provide maximum comfort and ergonomic hand positioning throughout the range of motion • Integrated foot pegs provide added support during heavy lifts

	PRODUCT DIMENSIONS (L X W X H)						PRODUCT WEIGHT		WEIGHT STACK	
	CM		INCHES				KG	LBS	KG	LBS
VS-S34	137.8	99.4	160.8	54.2	39.1	63.3	214	471	72.6	160
VS-S34P	137.8	99.4	167.1	54.2	39.1	65.8	249	547	104	230
VS-S34H	137.8	99.4	160.8	54.2	39.1	63.3	246	541	104	230

* Products shown as Versa+



BICEPS CURL

Arm pad is angled for stability and limits unwanted shoulder movement during exercise • Optimized pivot location creates biomechanically correct range of motion

	PRODUCT DIMENSIONS (L X W X H)				PRODUCT WEIGHT		WEIGHT STACK			
	CM	INCHES			KG	LBS	KG	LBS		
VS-S40	121.8	127	160.8	48	50	63.3	216	475	68	150
VS-S40P	121.8	127	167.1	48	50	65.8	242	531	91	200
VS-S40H	121.8	127	160.8	48	50	63.3	239	525	91	200



TRICEPS PRESS

Rotating handles adapt to users of all sizes • Angled back pad reduces stress, improves stabilization and enhances comfort

	PRODUCT DIMENSIONS (L X W X H)					PRODUCT WEIGHT		WEIGHT STACK		
	CM	INCHES			KG	LBS	KG	LBS		
VS-S42	157.7	107.5	160.8	62.1	42.3	63.3	256	564	72.6	160
VS-S42P	157.7	107.5	167.1	62.1	42.3	65.8	291	640	104	230
VS-S42H	157.7	107.5	160.8	62.1	42.3	63.3	288	634	104	230



BACK EXTENSION

Multi-position foot placement accommodates a variety of users • Contoured back pad enhances comfort

	PRODUCT DIMENSIONS (L X W X H)				PRODUCT WEIGHT		WEIGHT STACK			
	CM	INCHES			KG	LBS	KG	LBS		
VS-S52	133.5	126.4	160.8	52.6	49.8	63.3	227	500	72.6	160
VS-S52P	133.5	126.4	167.1	52.6	49.8	65.8	262	576	104	230
VS-S52H	133.5	126.4	160.8	52.6	49.8	63.3	259	570	104	230



ABDOMINAL

3-position design trains abdominals and obliques for added exercise variety and core rotation • Ergonomic back pad improves range of motion and enhances comfort

	PRODUCT DIMENSIONS (L X W X H)				PRODUCT WEIGHT		WEIGHT STACK			
	CM	INCHES			KG	LBS	KG	LBS		
VS-S53	136.6	141.4	160.8	53.8	55.7	63.3	197	433	72.6	160
VS-S53P	136.6	141.4	167.1	53.8	55.7	65.8	232	509	104	230
VS-S53H	136.6	141.4	160.8	53.8	55.7	63.3	229	503	104	230

* Products shown as Versa+



LEG PRESS/CALF PRESS

One-handed start adjustment for ease of use • Gas-assisted foot platform provides smoother adjustments • Assistance handle and low step-over height offer easy access • Foot plate identifies user foot position with unique visual indicators

	PRODUCT DIMENSIONS (L X W X H)					PRODUCT WEIGHT		WEIGHT STACK		
	CM	INCHES				KG	LBS	KG	LBS	
VS-S70	232.4	102.4	160.8	91.5	40.3	63.3	361	795	188	415
VS-S70P	232.4	102.4	167.1	91.5	40.3	65.8	364	801	188	415
VS-S70H	232.4	102.4	160.8	91.5	40.3	63.3	361	795	188**	415**



LEG EXTENSION

Angled seat and back pads encourage full quadriceps contraction • Self-adjusting tibia pad enhances comfort • Pivot location is clearly marked to encourage correct alignment • Back pad ratchets forward for easy adjustment from seated position

	PRODUCT DIMENSIONS (L X W X H)					PRODUCT WEIGHT		WEIGHT STACK		
	CM	INCHES				KG	LBS	KG	LBS	
VS-S71	183.5	128.9	160.8	72.3	50.7	63.3	243	536	72.6	160
VS-S71P	183.5	128.9	167.1	72.3	50.7	65.8	278	612	104	230
VS-S71H	183.5	128.9	160.8	72.3	50.7	63.3	275	606	104	230



SEATED LEG CURL

Angled seat and unique pivot location encourage full hamstring contraction • Tibia pad and range-of-motion adjustments are easily accessible from seated position • Back pad ratchets forward for easy adjustment from seated position • Adjustable thigh pad provides stabilization during exercise

	PRODUCT DIMENSIONS (L X W X H)						PRODUCT WEIGHT		WEIGHT STACK	
	CM		INCHES				KG	LBS	KG	LBS
VS-S72	176.9	113.3	160.8	69.7	44.6	63.3	253	556	68	150
VS-S72P	176.9	113.3	167.1	69.7	44.6	65.8	278	612	91	200
VS-S72H	176.9	113.3	160.8	69.7	44.6	63.3	275	606	91	200



GLUTE

Adjustable chest pad accommodates users of all sizes • Low step-height stabilization platform allows for ease of use • Upright user position, contoured elbow pads and large foot pad enhance comfort

	PRODUCT DIMENSIONS (L X W X H)						PRODUCT WEIGHT		WEIGHT STACK	
	CM		INCHES				KG	LBS	KG	LBS
VS-S78	177.8	99.9	160.8	70	39.3	63.3	185	409	68	150
VS-S78P	177.8	99.9	167.1	70	39.3	65.8	188	415	68	150
VS-S78H	177.8	99.9	160.8	70	39.3	63.3	185	409	68**	150**

* Products shown as Versa+

VERSA DUALS /

MORE FUNCTION, LESS SPACE

The expanded versatility of our dual stations makes it easy to create a weight-training collection just right for your space, your budget and the people you serve. By mixing and matching a range of our two-in-one stations, you can make the most of your floor space while providing a complete strength training experience. Intuitive adjustment, incremental weight control and clearly illustrated placards make it easy for users of all ability levels to smoothly transition from one exercise to the next, while ergonomic design adds comfort to every workout. Choose from eight dual-station units, customize with weight stack options or our premium Versa+ package, and complete your offering with more Versa single-station units.







MULTI-PRESS

Designed for easy entry and exit • Smoothly transition between exercises with one simple adjustment • Dual-position hand grips allow for greater training variety • Elevated foot rests provide stability and comfort during heavy lifts • Reclined position offers greater lumbar support • Clearly indicated adjustments for ease of use

	PRODUCT DIMENSIONS (L X W X H)					PRODUCT WEIGHT		WEIGHT STACK		
	CM	INCHES	CM	INCHES	CM	INCHES	KG	LBS	KG	LBS
VS-S131	154.3	157.2	199.9	60.7	61.9	78.7	236	520	72.6	160
VS-S131P	154.3	157.2	199.9	60.7	61.9	78.7	271	596	104	230
VS-S131H	154.3	157.2	199.9	60.7	61.9	78.7	268	590	104	230



REAR DELT / PEC FLY

Comfortable, oversized grips accommodate users of all sizes • Always forward-facing user position enhances comfort and ease of use • Wide motion for improved biomechanics and dual function

	PRODUCT DIMENSIONS (L X W X H)					PRODUCT WEIGHT		WEIGHT STACK		
	CM	INCHES	CM	INCHES	CM	INCHES	KG	LBS	KG	LBS
VS-S22	150.5	169	160.8	59.2	66.5	63.3	224	492	68	150
VS-S22P	150.5	169	167.1	59.2	66.5	65.8	259	548	91	200
VS-S22H	150.5	169	160.8	59.2	66.5	63.3	256	542	91	200



LAT PULLDOWN / SEATED ROW

Thigh pad easily adjusts to provide stability and comfort • Elevated foot rests provide stability and comfort during heavy lifts • Stainless-steel cable guides provide added protection for lasting durability • Clearly indicated adjustments for ease of use

	PRODUCT DIMENSIONS (L X W X H)						PRODUCT WEIGHT		WEIGHT STACK	
	CM		INCHES				KG	LBS	KG	LBS
VS-S331	180.5	157.9	226.3	71.1	62.2	89.1	246	543	72.6	160
VS-S331P	180.5	157.9	226.3	71.1	62.2	89.1	281	619	104	230
VS-S331H	180.5	157.9	226.3	71.1	62.2	89.1	278	613	104	230



BICEPS / TRICEPS

Compact design minimizes floor space • Stainless-steel cable guides provide added protection for lasting durability • Large foot platform provides stability

	PRODUCT DIMENSIONS (L X W X H)						PRODUCT WEIGHT		WEIGHT STACK	
	CM		INCHES				KG	LBS	KG	LBS
VS-S401	166.6	124.7	226.2	65.6	49.1	89.1	214	472	68.0	150
VS-S401P	166.6	124.7	226.2	65.6	49.1	89.1	240	528	91	200
VS-S401H	166.6	124.7	226.2	65.6	49.1	89.1	237	522	91	200



AB / LOW BACK

Angled seat and lumbar pad enhance user comfort • Multi-position foot placement accommodates a variety of users • Low handle positions offer easy entry and exit and provide stability • Clearly indicated adjustments for ease of use

	PRODUCT DIMENSIONS (L X W X H)				PRODUCT WEIGHT		WEIGHT STACK			
	CM	INCHES			KG	LBS	KG	LBS		
VS-S531	132.2	131.5	160.8	52.1	51.8	63.3	231	509	72.6	160
VS-S531P	132.2	131.5	167.1	52.1	51.8	65.8	266	585	104	230
VS-S531H	132.2	131.5	160.8	52.1	51.8	63.3	263	579	104	230



CHIN / DIP ASSIST

Multi-position pull-up handles for greater exercise variety • Ideally angled dip grips encourage proper wrist placement and muscle variation • Gas-assisted knee platform folds up for unassisted bodyweight exercises and training variety • Large, textured foot platforms provide easy entry and exit • Knee platform features a protective top pad for added training security • Integrated hard stop prevents knee pad disengagement • Clearly indicated adjustments for ease of use

	PRODUCT DIMENSIONS (L X W X H)				PRODUCT WEIGHT		WEIGHT STACK			
	CM	INCHES			KG	LBS	KG	LBS		
VS-S601	142.8	152.8	219.7	56.2	60.2	86.5	307	676	62.1	135
VS-S601P	142.8	152.8	219.7	56.2	60.2	86.5	310	682	62.1	135
VS-S601H	142.8	152.8	219.7	56.2	60.2	86.5	307	676	62.1	135



LEG EXTENSION / LEG CURL

Angled pads and ideal pivot location promote full muscle contraction and alignment for both exercises • Dual-action CAM enables a smooth transition between exercises and prevents cable slack • Adjustments are easily performed in the seated position • Back pad ratchets forward for easy adjustment from the seated position • Clearly indicated adjustments for ease of use

	PRODUCT DIMENSIONS (L X W X H)				PRODUCT WEIGHT		WEIGHT STACK			
	CM	INCHES			KG	LBS	KG	LBS		
VS-S711	177.6	118.3	160.8	69.9	46.6	63.3	251	554	72.6	160
VS-S711P	177.6	118.3	167.1	69.9	46.6	65.8	286	630	104	230
VS-S711H	177.6	118.3	160.8	69.9	46.6	63.3	283	624	104	230



HIP ADDUCTOR / ABDUCTOR

Dual-function machine saves space and increases functionality • Reclined position provides greater comfort • Clearly indicated adjustments allow for ease of use

	PRODUCT DIMENSIONS (L X W X H)				PRODUCT WEIGHT		WEIGHT STACK			
	CM	INCHES			KG	LBS	KG	LBS		
VS-S74	169.6	159.1	160.8	66.8	62.6	63.3	235	516	72.6	160
VS-S74P	169.6	159.1	167.1	66.8	62.6	65.8	269	592	104	230
VS-S74H	169.6	159.1	160.8	66.8	62.6	63.3	266	586	104	230



MEDICAL LEG PRESS

Class I Med CE certified for therapeutic, rehab and active-aging environments creating a wide range of progression programs, including isometric, loaded isometric, isotonic, plyometric, elastic and combined (elastic and weight stack) exercises • Low starting weight of 2.63 kg / 5.8 lbs. offers gradual progression • Adjustable shoulder pads and gas-assisted seat back provide flexible progressions and comfortable use for clients of all sizes • Stack disconnect allows free movement of the carriage without additional resistance, ideal for deconditioned, rehabbing and injured clients • Band hooks make it easy to add external resistance bands for elastic and plyometric training • Carriage lockout and range-of-motion limiter restrict carriage movement for isometric contractions while protecting clients from overextending • Also available: optional incremental weights, step stool, force plate holder and accessory package

	PRODUCT DIMENSIONS (L X W X H)						PRODUCT WEIGHT		WEIGHT STACK	
	CM		INCHES				KG	LBS	KG	LBS
MD-S70	263.2	121.9	188.3	103.7	48	74.2	372	820	136	300



MEDICAL LEG EXTENSION / LEG CURL

Class I Med CE certified for therapeutic, rehab and active-aging environments creating progression programs to build strength in the hamstrings and quads • Unique seat pivot allows proper joint alignment creating optimal biomechanics in both directions • Gas-assisted adjustments combined with a rotating thigh pad for open exit and entry provide an exceptional user experience • The range-of-motion limiter and 12 starting positions allow complete control over stroke length and isometric contractions • Low starting weight of 4.5 kg / 10 lbs. • Also available: optional incremental weights and step stool

	PRODUCT DIMENSIONS (L X W X H)						PRODUCT WEIGHT		WEIGHT STACK	
	CM		INCHES				KG	LBS	KG	LBS
MD-S711	165.4	125.4	162.5	65.2	49.4	64	340	750	91	200



MEDICAL ADJUSTABLE PULLEY

Class I Med CE certified for therapeutic, rehab and active-aging environments creating a wide range progression programs including exercises that build upper body, lower body and core muscles that are essential to ADLs • 35 clearly numbered adjustment points provide exercise variety • Low starting weight of 2.3 kg / 5 lbs. offers gradual progression • 1:2 pulley ratio provides smooth operation • Also available: optional incremental weight, balance bar, medical handrail, wheel transport and Inclusive Fitness kit

	PRODUCT DIMENSIONS (L X W X H)						PRODUCT WEIGHT		WEIGHT STACK	
	CM		INCHES				KG	LBS	KG	LBS
MD-AP	107.2	125	228	42.2	49.3	89.8	174	384	68	150

* Products shown with optional accessories.

VERSA FUNCTIONAL TRAINER /

SPACE-SAVING VERSATILITY

The smart design of our functional trainer provides a remarkable range of exercise options in a space-saving footprint. Incremental weight adjustment and a 1:2 pulley ratio make it easy to control exercise intensity and create progressions right for everyone from deconditioned users to elite athletes. Everything about our functional trainer — from the multi-grip pull-up bar to the color-coded adjustment points to the professionally illustrated exercise placards — offers intuitive operation for users and trainers alike. Optional storage makes it easy to organize and stow accessories for instant access, and the completely enclosed design protects the unit's moving parts while creating a solid, cohesive aesthetic on your floor.





FUNCTIONAL TRAINER

Multi-position pull-up handles for greater exercise variety • Fully enclosed weight stacks protect the machine's internal components • Enhanced placards highlight targeted muscle groups and proper user positioning for a wide range of exercises • One-handed pulley adjustment offers easy operation • Frame guards protect against chips and scratches • Clearly indicated adjustments for ease of use • Compact design accommodates placement in spaces with ceilings as low as 2.4 m / 8' • 76 cm / 30" connection provides ample storage for functional training accessories • 1:2 pulley ratio provides smooth operation • Standard effective resistance 34 kg / 75 lbs. (per side) • Also available: VS-VFT-S18 Functional Trainer with 46 cm / 18" connection to accommodate optional training handles • Optional: VS-VFT60 heavy stack for added 13.6 kg / 30 lbs. of resistance per side for 47.6 kg / 105 lbs. effective resistance • Optional accessory: VS-FTHP handle package includes four training handles (v-bar, curl bar, ropes, ankle strap) • Optional: VS-FTIW 2.2 kg / 5 lb. increment weight (effective resistance 1.1 kg / 5lb.)

	PRODUCT DIMENSIONS (L X W X H)					PRODUCT WEIGHT		WEIGHT STACK		
	CM	CM	CM	CM	INCHES	KG	LBS	KG	LBS	
VS-VFT-S18	111.8	160.0	237.6	44.0	63	93.5	355	782	68	150
VS-VFT-S30	122.7	145.8	237.6	48.3	57.4	93.5	369	814	68	150
VS-VFT-S18 + VS-VFT60	111.8	160.0	237.6	44.0	63	93.5	409	902	95	210
VS-VFT-S30 + VS-VFT60	122.7	145.8	237.6	48.3	57.4	93.5	424	934	95	210

* Accessories not included.

VERSA STANDARD FRAME COLORS



Iced Silver†



Black Glossy



Matte Black



Lace White



Polarized Titanium

VERSA UPHOLSTERY COLOR OPTIONS



Black

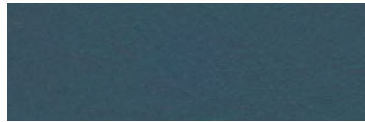

Slate Blue



Clay Red



Graphite



Alloy

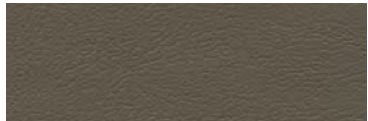

Hazelnut



Alloy / Graphite



Hazelnut / Alloy



American Beauty



Candy Apple



New Burgundy



Paprika



Nasturtium



Mandarin Orange



Sun Yellow



Marigold



Emerald



Hunter Green



Royal Blue



Bluejay



New Purple



Navy



Bucksuede



Allspice



Cadet

Frame and upholstery colors applicable to the USA. Product pricing is reflective of **standard** upholstery only. Other color options available at an additional charge.
 NOTE: Actual product colors may vary from what is shown here. † Iced Silver is stocked frame color. Additional lead times may apply for other frame colors



AURA SERIES /

THE STANDARD IN PERFORMANCE AND DESIGN





AURA SERIES /

A superior blend of features and sophistication, the Aura Series appeals to fitness enthusiasts of all kinds. Independent converging and diverging motions on select units provide a natural resistance movement that feels smooth and natural. Ergo Form™ cushions ensure proper body alignment and support while introducing an extra touch of style. In addition to offering a unique aesthetic distinction that attracts users, our round-tube construction with automotive-quality powder-coat finish provides lasting strength and durability.



Frame and Finish Attractive round-tube construction provides unmatched strength, and automotive-quality finish is highly resistant to chips and scratches. **Bottle and Towel Holder** Conveniently positioned to prevent spills and clutter on your floor. **Exercise Placards** Easy-to-read reference cards highlight targeted muscle groups and proper machine use. **Ergo Form Cushions** Uniquely attractive design ensures proper body alignment and support. **Incremental Weights** Easy to access and reference from the seated position. **Converging/Diverging Motion** Encourages a natural path of motion to enhance comfort.



1

2

CHEST PRESS

- Adjust seat height so handgrips are at mid-chest
- When seated, use overhead pull pin to adjust handgrip-starting position





CHEST PRESS

Adjustable pressing arm allows users to determine their own range of motion • Oversized, dual-position hand grips provide greater comfort and variety

	PRODUCT DIMENSIONS (L X W X H)						PRODUCT WEIGHT		WEIGHT STACK	
	CM			INCHES			KG	LBS	KG	LBS
G3-S10	127	155.9	184.7	50	61.4	72.7	275	607	113	250



PECTORAL FLY

Dual hand grips accommodate users of all sizes • Independent arm action ensures more balanced exercise by not allowing the dominant side to control the exercise • Adjustable starting position allows for greater range of motion

	PRODUCT DIMENSIONS (L X W X H)						PRODUCT WEIGHT		WEIGHT STACK	
	CM			INCHES			KG	LBS	KG	LBS
G3-S12	113.3	156.8	150.6	44.6	61.7	59.3	246	542	91	200



CONVERGING CHEST PRESS

Independent converging motion arms • Dual hand-grip positions provide greater training variety • Designed for easy entry and exit

	PRODUCT DIMENSIONS (L X W X H)						PRODUCT WEIGHT		WEIGHT STACK	
	CM		INCHES				KG	LBS	KG	LBS
G3-S13	128.3	155.1	174.8	50.5	61.1	68.8	293	645	113	250



SHOULDER PRESS

Dual-position hand grips allow for greater training variety • Oversized hand grips provide improved function and comfort • Counterbalanced pressing arm provides reduced starting resistance

	PRODUCT DIMENSIONS (L X W X H)						PRODUCT WEIGHT		WEIGHT STACK	
	CM		INCHES				KG	LBS	KG	LBS
G3-S20	152	146.9	150.7	59.8	57.8	59.3	251	553	91	200



LATERAL RAISE

Independent arm action ensures balanced exercise • Handles pivot to accommodate users of all sizes

	PRODUCT DIMENSIONS (L X W X H)						PRODUCT WEIGHT		WEIGHT STACK	
	CM			INCHES			KG	LBS	KG	LBS
G3-S21	154.2	152.4	150.6	60.7	60	59.3	271	597	91	200



REAR DELT / FLY

User arms pivot to accommodate individual forearm lengths and varying paths of motion • Optimized handle positions reduce the need to adjust the seat position between rear deltoid and fly exercises

	PRODUCT DIMENSIONS (L X W X H)						PRODUCT WEIGHT		WEIGHT STACK	
	CM			INCHES			KG	LBS	KG	LBS
G3-S22	136.8	191.6	204.3	53.9	75.4	80.4	294	648	134	295



CONVERGING SHOULDER PRESS

Independent converging motion arms • Pressing arm includes both standard and neutral grips for user preference • Oversized hand grips provide greater comfort and variety

	PRODUCT DIMENSIONS (L X W X H)						PRODUCT WEIGHT		WEIGHT STACK	
	CM			INCHES			KG	LBS	KG	LBS
G3-S23	153.8	149.3	173.6	60.6	58.8	68.4	251	553	91	200



LAT PULLDOWN

Thigh pads easily adjust to provide both stability and comfort • Straight bar with angled ends ensures correct arm and wrist position throughout the entire range of motion

	PRODUCT DIMENSIONS (L X W X H)						PRODUCT WEIGHT		WEIGHT STACK	
	CM			INCHES			KG	LBS	KG	LBS
G3-S30	146.4	119.6	221.7	57.6	47.1	87.3	250	551	134	295



SEATED ROW

Dual-position hand grips allow for greater training variety • Optimized pivot location creates a biomechanically correct arc of motion

	PRODUCT DIMENSIONS (L X W X H)						PRODUCT WEIGHT		WEIGHT STACK	
	CM			INCHES			KG	LBS	KG	LBS
G3-S31	151.4	92.1	210.6	59.6	36.3	82.9	273	601	113	250



DIVERGING LAT PULLDOWN

Independent diverging motion arms • Angled seat cues optimal user position • High pads easily adjust to provide both stability and comfort

	PRODUCT DIMENSIONS (L X W X H)						PRODUCT WEIGHT		WEIGHT STACK	
	CM			INCHES			KG	LBS	KG	LBS
G3-S33	146.7	88.4	211.7	57.8	34.8	83.3	237	527	113	250



DIVERGING SEATED ROW

Independent diverging motion arms • Dual-position hand grips provide greater training variety

	PRODUCT DIMENSIONS (L X W X H)						PRODUCT WEIGHT		WEIGHT STACK	
	CM			INCHES			KG	LBS	KG	LBS
G3-S34	154.4	87.9	198.7	60.8	34.6	78.2	259	570	113	250



ARM CURL

Arm pad is angled for stability and limits unwanted shoulder movement during exercise • Angled rotating hand grips ensure optimal wrist position

	PRODUCT DIMENSIONS (L X W X H)						PRODUCT WEIGHT		WEIGHT STACK	
	CM			INCHES			KG	LBS	KG	LBS
G3-S40	122	108.6	150.6	48.1	42.8	59.3	228	502	91	200



TRICEPS PRESS

Rotating handles adapt to users of all sizes • Over-molded grips ensure a secure, non-slip feel • Angled back pad reduces stress, improves stabilization and enhances comfort

	PRODUCT DIMENSIONS (L X W X H)						PRODUCT WEIGHT		WEIGHT STACK	
	CM		INCHES				KG	LBS	KG	LBS
G3-S42	158.8	128	173.6	62.5	50.4	68.4	261	575	91	200



TRICEPS EXTENSION

Seat and upper-arm pads are angled to enhance user stability during exercise • Handle pivots adjust for varying forearm lengths

	PRODUCT DIMENSIONS (L X W X H)						PRODUCT WEIGHT		WEIGHT STACK	
	CM		INCHES				KG	LBS	KG	LBS
G3-S45	117.4	108.4	150.6	46.2	42.7	59.3	223	491	91	200



ABDOMINAL CRUNCH

Dual axis of rotation enhances user feel for a natural crunch movement and muscle contraction • Seat and handle positions enhance user stability

	PRODUCT DIMENSIONS (L X W X H)						PRODUCT WEIGHT		WEIGHT STACK	
	CM		INCHES				KG	LBS	KG	LBS
G3-S51	142.8	112.2	150.5	56.2	44.2	59.3	184	405	91	200



BACK EXTENSION

Adjustable nonskid footrests provide secure and proper positioning • Lower-back reference pad encourages proper user alignment

	PRODUCT DIMENSIONS (L X W X H)						PRODUCT WEIGHT		WEIGHT STACK	
	CM		INCHES				KG	LBS	KG	LBS
G3-S52	157.7	106.5	174.9	62.1	41.9	68.9	277	610	134	295



ROTARY TORSO

Unique design reinforces proper user positioning • Range of motion is adjustable in 10-degree increments • Foot bar helps users of all sizes achieve proper stabilization

	PRODUCT DIMENSIONS (L X W X H)						PRODUCT WEIGHT		WEIGHT STACK	
	CM		INCHES				KG	LBS	KG	LBS
G3-S55	164.2	97	173.7	64.6	38.2	68.4	216	476	91	200



DIP / CHIN ASSIST

Rotating dip handles adapt to users of all sizes • Pull-up bar offers both standard and neutral grips for individual preference • 2 sets of pull-up grips allow users of all heights a full range of motion

	PRODUCT DIMENSIONS (L X W X H)						PRODUCT WEIGHT		WEIGHT STACK	
	CM		INCHES				KG	LBS	KG	LBS
G3-S60	117.6	121.8	230.7	46.3	47.9	90.8	229	505	68	150



LEG PRESS

4-bar linkage enhances alignment and provides variable resistance • Large nonskid footplate accommodates users of all sizes

	PRODUCT DIMENSIONS (L X W X H)						PRODUCT WEIGHT		WEIGHT STACK	
	CM		INCHES				KG	LBS	KG	LBS
G3-S70	210.1	124.6	184.6	82.7	49	72.7	417	920	175	385



LEG EXTENSION

Angled seat and back pads encourage full quadriceps contraction • Adjustable start position facilitates increased range of motion • Self-adjusting tibia pad enhances comfort

	PRODUCT DIMENSIONS (L X W X H)						PRODUCT WEIGHT		WEIGHT STACK	
	CM		INCHES				KG	LBS	KG	LBS
G3-S71	178.9	109.4	173.6	70.4	43.1	68.4	265	584	113	250



SEATED LEG CURL

Seat, back and tibia pads adjust without affecting knee alignment or start-position angle • Adjustable start position facilitates increased range of motion

	PRODUCT DIMENSIONS (L X W X H)						PRODUCT WEIGHT		WEIGHT STACK	
	CM		INCHES				KG	LBS	KG	LBS
G3-S72	178.9	109.4	173.6	70.4	43.1	68.4	257	566	113	250



PRONE LEG CURL

Divergent pad angle eliminates lower-back stress • Standard range of motion adjusts for individual preference

	PRODUCT DIMENSIONS (L X W X H)						PRODUCT WEIGHT		WEIGHT STACK	
	CM		INCHES				KG	LBS	KG	LBS
G3-S73	177.5	111.7	173.6	69.9	44	68.3	272	600	91	200



HIP ADDUCTOR

Knee pads and dual footrests provide leg support and enhanced comfort • Weight stack positioned in front of the user acts as a shield, providing enhanced privacy

	PRODUCT DIMENSIONS (L X W X H)						PRODUCT WEIGHT		WEIGHT STACK	
	CM		INCHES				KG	LBS	KG	LBS
G3-S74	166.6	164.3	150.8	65.6	64.7	59.4	264	582	100	220



HIP ABDUCTOR

Knee pads and dual footrests provide leg support to eliminate unwanted torque around the knee • Weight stack positioned in front of the user acts as a shield, providing enhanced privacy

	PRODUCT DIMENSIONS (L X W X H)						PRODUCT WEIGHT		WEIGHT STACK	
	CM		INCHES				KG	LBS	KG	LBS
G3-S75	166.6	107.5	150.8	65.6	42.3	59.4	270	595	100	220



ROTARY HIP

Standing position provides enhanced alignment and increased target muscle involvement • Adjustable carriage allows users of varying heights to achieve optimal positioning • Starting positions are incremental at 15-degree intervals through 270 degrees of rotation • Low step-up height 13.2 cm / 5.2" for easy entry and exit

	PRODUCT DIMENSIONS (L X W X H)						PRODUCT WEIGHT		WEIGHT STACK	
	CM		INCHES				KG	LBS	KG	LBS
G3-S76	111.7	119.7	184.3	44	47.1	72.6	295	650	134	295



CALF PRESS

Force is transmitted through hips to eliminate spinal compression • Footplates are curved for comfortable positioning and a full range of motion • Fully enclosed linear bearings provide smooth, quiet motion

	PRODUCT DIMENSIONS (L X W X H)						PRODUCT WEIGHT		WEIGHT STACK	
	CM		INCHES				KG	LBS	KG	LBS
G3-S77	173	68.9	150.5	68.1	27.1	59.3	304	670	134	295

FUNCTIONAL TRAINER

1:4 pulley ratio offers low starting resistance and high-speed movements • Available with 132-kg / 290-lb. or 177-kg / 390-lb. stacks • Standard swiveling accessory station includes 10 attachments • Multi-grip-position pull-up handles with unique rock-climbing attachment • Integrated fold-away step offers easy access • G3-MSFT300 effective resistance: 32.9-kg / 72.5-lbs. (per side) • G3-MSFT400 effective resistance: 44.2-kg / 97.5-lbs. (per side)



	PRODUCT DIMENSIONS (L X W X H)						PRODUCT WEIGHT		WEIGHT STACK	
	CM		INCHES				KG	LBS	KG	LBS
G3-MSFT300	169.2	130.2	234.4	66.6	51.2	92.3	601	1324	2 X 131	2 X 290
G3-MSFT400	169.2	130.2	234.4	66.6	51.2	92.3	697	1537	2 X 176	2 X 390



Flanged pulley housing

ADJUSTABLE CABLE CROSSOVER

Widely spaced, dual-adjustable pulleys offer exercise variety • Pull-up bar with both lat and neutral grips provide hand placement options • One-handed adjustment makes operation easy • Flanged pulley housing minimizes cable wear and increases durability • 1:2 pulley ratio provides smooth operation



	PRODUCT DIMENSIONS (L X W X H)						PRODUCT WEIGHT		WEIGHT STACK	
	CM	INCHES	CM	INCHES	CM	INCHES	KG	LBS	KG	LBS
G3-MS20	397.4	90	239.6	156.5	35.4	94.3	399	880	2 X 91	2 X 200

CONFIGURABILITY

Meet the strength training needs of multiple users and maximize training options with customized Aura Multi-Stations. Available in 4, 5, 8, 12 and 16-Stack configurations, the Aura series can fit into any space and budget.



5-STACK MULTI-STATION

	PRODUCT DIMENSIONS (L X W X H)						PRODUCT WEIGHT			WEIGHT STACK		
	CM		INCHES				KG	LBS	KG	LBS	KG	LBS
G3-MS50	561.3	370.9	251.7	221	146	99.1	1996	4400	4 X 91	4 X 200	4 X 134	4 X 295



4-STACK MULTI-STATION

	PRODUCT DIMENSIONS (L X W X H)						PRODUCT WEIGHT		WEIGHT STACK	
	CM			INCHES			KG	LBS	KG	LBS
G3-MS40	167.8	369.8	252	66.1	145.6	99.2	998	2200	2 X 91 2 X 134	2 X 200 2 X 295

ADJUSTABLE PULLEY

Single-handed height adjustment offers easy use • 1:2 pulley ratio provides smooth movement and smaller incremental weight changes • Balance bar adds support during exercise • Includes water bottle holder and towel hook • Modular design is easily customized to your space



	PRODUCT DIMENSIONS (L X W X H)						PRODUCT WEIGHT		WEIGHT STACK	
	CM			INCHES			KG	LBS	KG	LBS
G3-MS24	68	70	240	27	28	94.5	181	398.5	91	200

LAT PULLDOWN

Two independent cables add training variety • Pivoting knee pad allows for quick and easy adjustments • Includes water bottle holder and towel hook • Modular design is easily customized to your space



	PRODUCT DIMENSIONS (L X W X H)						PRODUCT WEIGHT		WEIGHT STACK	
	CM			INCHES			KG	LBS	KG	LBS
G3-MS51	140	120	252	55	47.5	99.5	252	556	134	295



8-STACK MULTI-STATION

	PRODUCT DIMENSIONS (L X W X H)						PRODUCT WEIGHT		WEIGHT STACK	
	CM			INCHES			KG	LBS	KG	LBS
G3-MS80	561.3	370.9	251.7	221	146	99.1	1996	4400	4 X 91 4 X 134	4 X 200 4 X 295

TRICEPS PRESSDOWN

Swiveling top pulley enhances durability • 1:1 pulley ratio allows for heavy training • Additional stability pad enhances comfort • Includes water bottle holder and towel hook • Modular design is easily customized to your space



	PRODUCT DIMENSIONS (L X W X H)						PRODUCT WEIGHT		WEIGHT STACK	
	CM			INCHES			KG	LBS	KG	LBS
G3-MS52	85	59	240	33.5	23.5	94.5	171.5	377.5	91	200

LOW ROW

Two independent cables add training variety • Pivoting knee pad allows for quick and easy adjustments • Includes water bottle holder and towel hook • Modular design is easily customized to your space



	PRODUCT DIMENSIONS (L X W X H)						PRODUCT WEIGHT		WEIGHT STACK	
	CM			INCHES			KG	LBS	KG	LBS
G3-MS53	230	71	240	91	28	94.5	260	573	134	295

AURA STANDARD FRAME COLORS



Iced Silver†

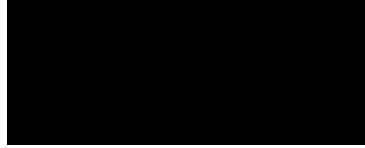

Black Glossy



Matte Black

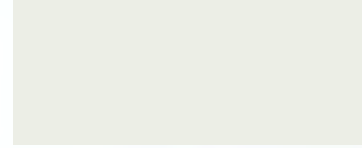

Lace White



Polarized Titanium

AURA UPHOLSTERY COLOR OPTIONS



Black

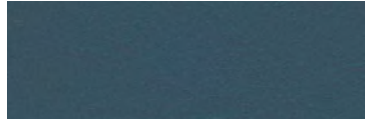

Slate Blue



Clay Red



Graphite



Alloy



Hazelnut



American Beauty



Candy Apple



New Burgundy



Paprika



Nasturtium



Mandarin Orange



Sun Yellow



Marigold



Emerald



Hunter Green



Royal Blue



Bluejay



New Purple



Navy



Bucksuede



Allspice



Cadet

Frame and upholstery colors applicable to the USA. Product pricing is reflective of **standard** upholstery only. Other color options available at an additional charge. NOTE: Actual product colors may vary from what is shown here. † Iced Silver is stocked frame color. Additional lead times may apply for other frame colors



GO SERIES /

DISCOVER THE STRENGTH OF SIMPLICITY





GO SERIES /

Ideal for users new to strength training and circuit programs, Go Series single stations are compact and easy-to-use creating a welcoming experience.



Enhanced Usability Minimal adjustments, low starting weight and optional incremental weight allows for smaller progressions that keep users of all abilities motivated as they gain strength. **Spacing-saving Design** Compact footprint with back-to-back configurations improves traffic flow and helps you serve more users when space is at a premium and budgets need to stretch further. **User Amenities** Storage space on top of stack lets users keep their personal device, water bottle and towel in reach while reducing clutter on your floor. **Exercise Placards** Large, easy-to-read reference cards highlight targeted muscle groups and proper machine use. **Streamlined Service & Maintenance** Guide rods can be removed without any tools, while a durable metal shroud withstands tough environments and can be easily removed to streamline service.





CHEST PRESS

Oversized neutral grips provide a natural, comfortable hold that reduces stress on shoulder joints • Intuitive design with no adjustments needed

	PRODUCT DIMENSIONS (L X W X H)						PRODUCT WEIGHT		WEIGHT STACK	
	CM			INCHES			KG	LBS	KG	LBS
GO-S13	158	118	137	62.2	46.6	54	166	366	72	160



SHOULDER PRESS

Intuitive design with no adjustments needed • Oversized neutral grips provide a natural, comfortable hold that reduces stress on shoulder joints

	PRODUCT DIMENSIONS (L X W X H)						PRODUCT WEIGHT		WEIGHT STACK	
	CM			INCHES			KG	LBS	KG	LBS
GO-S23	148	110.5	176	58.4	43.5	69.3	160	353	45	100



LAT PULLDOWN

Ratcheting seat adjusts easily, letting users fine tune the range of motion for optimal comfort and function • Oversized neutral grips offer a comfortable hold while reducing stress on shoulder joints

	PRODUCT DIMENSIONS (L X W X H)						PRODUCT WEIGHT		WEIGHT STACK	
	CM		INCHES				KG	LBS	KG	LBS
GO-S33	174	91	171	68.5	35.8	67.3	210	463	72	160



SEATED ROW

Oversized angled grips provide a natural, comfortable hold • Dual position foot pegs and an extra-long seat let users of different heights position themselves comfortably with no adjustments needed

	PRODUCT DIMENSIONS (L X W X H)						PRODUCT WEIGHT		WEIGHT STACK	
	CM		INCHES				KG	LBS	KG	LBS
GO-S34	148	123	137	58.3	48.5	54	159	350.5	72	160



BICEPS CURL

Intuitive design with no adjustments needed • Highlighted pivot point indicates optimal elbow positioning and body alignment • Extended seat lets users shift hip positioning for proper alignment

	PRODUCT DIMENSIONS (L X W X H)						PRODUCT WEIGHT		WEIGHT STACK	
	CM		INCHES				KG	LBS	KG	LBS
GO-S40	125	104	137	49.2	41	54	148	326.5	54	120



SEATED TRICEPS PRESS

Oversized neutral grips provide a natural, comfortable hold • Seated press motion follows a natural path, reducing stress on elbow joints, engaging the entire upper body and aiding in sit-to-stand progressions • Intuitive design with no adjustments needed

	PRODUCT DIMENSIONS (L X W X H)						PRODUCT WEIGHT		WEIGHT STACK	
	CM		INCHES				KG	LBS	KG	LBS
GO-S42	130.5	101.5	137	51.4	39.9	54	163	359.5	72	160



ABDOMINAL

Intuitive design with no adjustments needed • Comfortably contoured back pad provides a full range of motion, stretching core muscles in a way traditional flat back pads can't • Soft, oversized grips offer a comfortable hold

	PRODUCT DIMENSIONS (L X W X H)						PRODUCT WEIGHT		WEIGHT STACK	
	CM		INCHES				KG	LBS	KG	LBS
GO-S53	158	94.5	137	62.2	37.2	54	150.5	332	63	140



LEG PRESS

Low step-in height offers easy entry and exit • Clearly numbered adjustment points make each user's starting point easily identifiable and repeatable for faster starts • Large rubber foot platform with a textured surface offers comfortable, secure foot placement for a wide range of users

	PRODUCT DIMENSIONS (L X W X H)						PRODUCT WEIGHT		WEIGHT STACK	
	CM	INCHES		KG	LBS	KG	LBS	KG	LBS	
GO-S70	101	183.5	137	39.7	72.3	54	246	542.4	95	210



LEG EXTENSION

Extra-large seat offers comfortable support for users and faster transitions in and out of the unit • Self-adjusting tibia pad provides greater ease of use • Adjustable range of motion lets users with different degrees of knee mobility build strength

	PRODUCT DIMENSIONS (L X W X H)						PRODUCT WEIGHT		WEIGHT STACK	
	CM	INCHES		KG	LBS	KG	LBS	KG	LBS	
GO-S71	132	130	137	52	51.3	54	178	392.5	72	160



SEATED LEG CURL

Self-adjusting ankle pad provides greater ease of use • Adjustable range of motion lets users with different degrees of hamstring mobility build strength • Extra-large seat offers comfortable support for users and faster transitions in and out of the unit

	PRODUCT DIMENSIONS (L X W X H)						PRODUCT WEIGHT		WEIGHT STACK	
	CM	INCHES		KG	LBS	KG	LBS	KG	LBS	
GO-S72	128	109	137	50.5	43	54	198	436.5	54	120

GO SERIES STANDARD FRAME COLORS



Iced Silver†

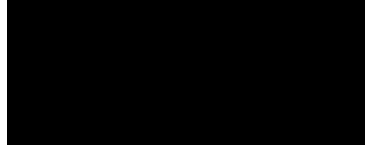

Black Glossy



Matte Black

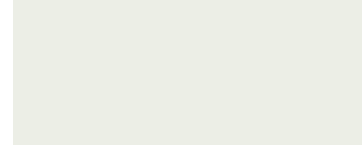

Lace White



Polarized Titanium

GO SERIES UPHOLSTERY COLOR OPTIONS



Black

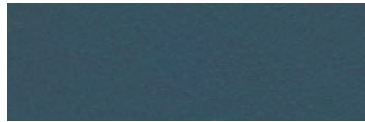

Slate Blue



Clay Red



Graphite



Alloy



Hazelnut



Alloy / Graphite



Hazelnut / Alloy



American Beauty



Candy Apple



New Burgundy



Paprika



Nasturtium



Mandarin Orange



Sun Yellow



Marigold



Emerald



Hunter Green



Royal Blue



Bluejay



New Purple



Navy



Bucksuede



Allspice



Cadet

Frame and upholstery colors applicable to the USA. Product pricing is reflective of **standard** upholstery only. Other color options available at an additional charge. NOTE: Actual product colors may vary from what is shown here. † Iced Silver is stocked frame color. Additional lead times may apply for other frame colors



MAGNUM SERIES /

A LEGACY OF PERFORMANCE AND PROVEN DURABILITY





MAGNUM SERIES /

Ideal for helping professional athletes reach their ultimate potential, the Magnum Series provides an unparalleled blend of performance and durability. Simple, exclusive Breaker Benches allow users to get into the start position with less stress on their joints. Other products like Double MEGA Racks pack in the functionality to help you make the most of your floor space. Best of all, everything that carries the Magnum Series name will withstand the most intense training environments.



Durable Construction Built to withstand the rigorous strength training of professional sports teams. **Converging/Diverging Motion** Encourages a natural path of motion to enhance comfort. **Ergonomics and Biomechanics** Designed for comfort while providing a natural, mechanically correct motion. **Color-coded Adjustment Points** Conveniently located and clearly marked for easy use. **Frame Finish** Automotive-quality finish is highly resistant to chips and scratches. **Variety** A robust selection meets the training needs of virtually any facility.



TOWER STATIONS /

MULTIPLE CONFIGURATIONS

The 19 different machines in the 900 series of tower stations provide the ultimate training variety for your customers. You can use them as stand-alone units, or you can link them to maximize your space and create the exact layout you want. Back-to-back or almost any other configuration is possible to fit your facility.

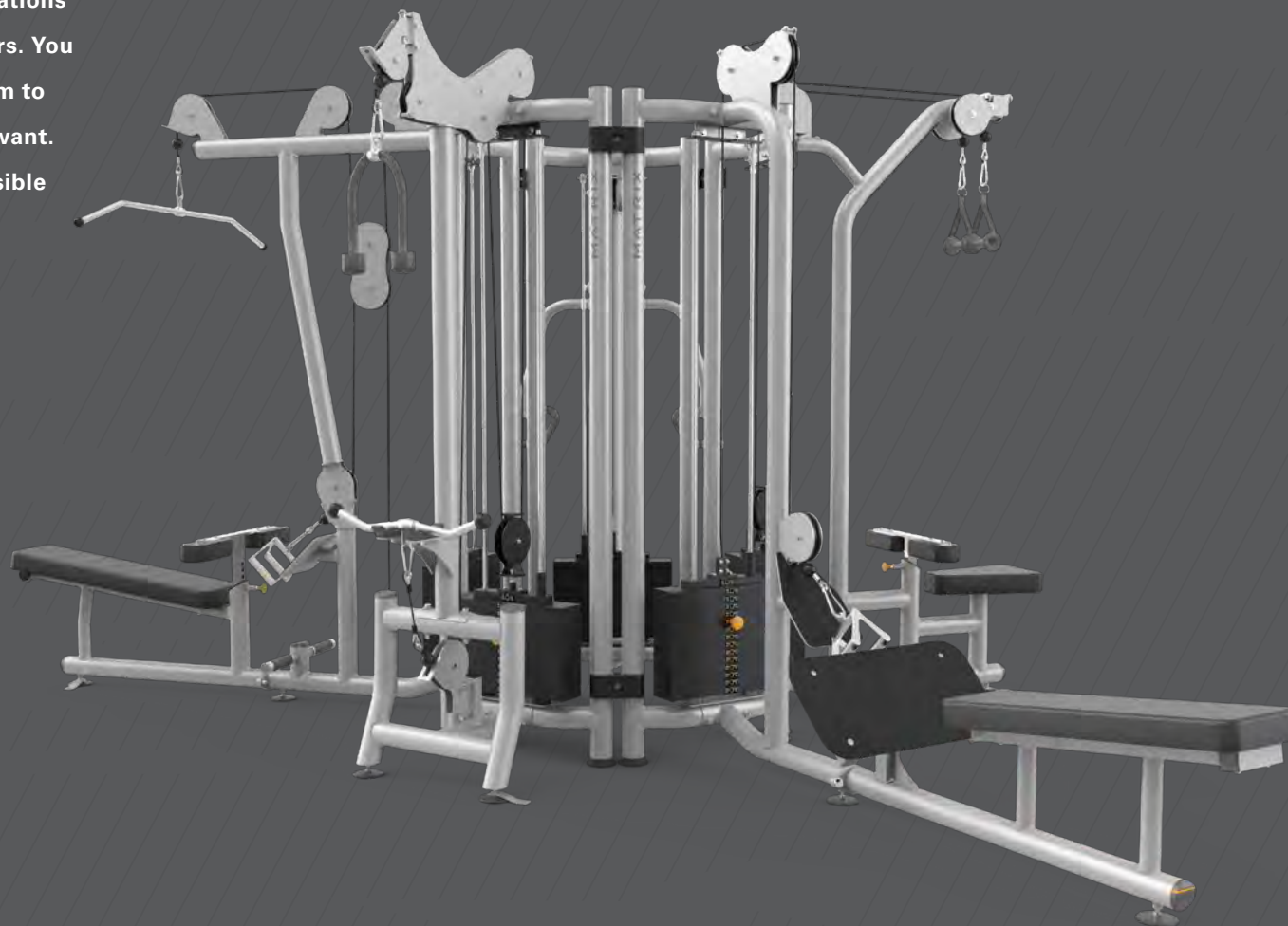



LAT PULLDOWN

Thigh pads easily adjust to provide stability and comfort • Available as a freestanding unit (MG-FS921)

	PRODUCT DIMENSIONS (L X W X H)						PRODUCT WEIGHT	
	CM			INCHES			KG	LBS
MG-921	127	69	234	50	27	92	231	510



DUAL-PULLEY LAT PULLDOWN

Thigh pads easily adjust to provide stability and comfort • Dual rotational pulleys for added exercise variety and independent motion • Available as a freestanding unit (MG-FSDP921)

	PRODUCT DIMENSIONS (L X W X H)						PRODUCT WEIGHT	
	CM			INCHES			KG	LBS
MG-DP921	127	69	234	50	27	92	244	538



ADJUSTABLE PULLEY

Column adjusts to provide exercise variety with 17 positions • Available as a freestanding unit (MG-FS923)

	PRODUCT DIMENSIONS (L X W X H)						PRODUCT WEIGHT	
	CM			INCHES			KG	LBS
MG-923	107	117	234	42	46	92	155	342



DUAL ADJUSTABLE PULLEY

Column adjusts into 17 positions • Dual rotational pulleys for added exercise variety and independent motion • Available as a freestanding unit (MG-FSDP923)

	PRODUCT DIMENSIONS (L X W X H)						PRODUCT WEIGHT	
	CM		INCHES				KG	LBS
MG-DP923	107	117	234	42	46	92	163	360



ADJUSTABLE CROSSOVER

1:2 ratio enables smooth resistance and extended travel • Large support handles provide extra stability • Available as a freestanding unit (MG-FS924)

	PRODUCT DIMENSIONS (L X W X H)						PRODUCT WEIGHT	
	CM		INCHES				KG	LBS
MG-924	69	366	234	27	144	92	330	728



LOW ROW

Large foot platform for added stability • Available as a freestanding unit (MG-FS926)

	PRODUCT DIMENSIONS (L X W X H)						PRODUCT WEIGHT	
	CM			INCHES			KG	LBS
MG-926	216	69	234	85	27	92	236	520



DUAL-PULLEY LOW ROW

Dual rotational pulleys for added exercise variety and independent motion • Available as a freestanding unit (MG-FSDP926)

	PRODUCT DIMENSIONS (L X W X H)						PRODUCT WEIGHT	
	CM			INCHES			KG	LBS
MG-DP926	216	69	234	85	27	92	243	535



REAR DELT / FLY

Dual grips for added variety and comfort • Dual function with a space-saving design • Available as a freestanding unit (MG-FS936)

	PRODUCT DIMENSIONS (L X W X H)						PRODUCT WEIGHT	
	CM			INCHES			KG	LBS
MG-936	135	81	229	53	32	90	194	428



DIP / CHIN ASSIST

Dual grips for added exercise variety • Dual function with a space-saving design • Large knee pad for comfort and stability • Available as a freestanding unit (MG-FS937)

	PRODUCT DIMENSIONS (L X W X H)						PRODUCT WEIGHT	
	CM	INCHES					KG	LBS
MG-937	170	97	234	67	38	92	181	400



TRICEPS PUSHDOWN

Compact, space-saving design • Large backpad for support • Available as a freestanding unit (MG-FS942)

	PRODUCT DIMENSIONS (L X W X H)						PRODUCT WEIGHT	
	CM	INCHES					KG	LBS
MG-942	107	117	234	42	46	92	220	485



ADJUSTABLE PULLEY [1:4]

Column adjusts to provide exercise variety with 17 positions • 1:4 Pulley Ratio to allow for explosive movements • Available as a freestanding unit (MG-FS943)

	PRODUCT DIMENSIONS (L X W X H)						PRODUCT WEIGHT	
	CM	INCHES					KG	LBS
MG-943	81	90	235	32	35	92	213	470



DUAL ADJUSTABLE PULLEY [1:4]

Column adjusts to provide exercise variety with 17 positions • 1:4 Pulley Ratio to allow for explosive movements • Available as a freestanding unit (MG-FSDP943)

	PRODUCT DIMENSIONS (L X W X H)						PRODUCT WEIGHT	
	CM		INCHES				KG	LBS
MG-DP943	81	72	235	32	28	92	216	475



ADJUSTABLE CROSSOVER [1:4]

Column adjusts to provide exercise variety with 17 positions • 1:4 Pulley Ratio to allow for explosive movements • Available as a freestanding unit (MG-FS944)

	PRODUCT DIMENSIONS (L X W X H)						PRODUCT WEIGHT	
	CM		INCHES				KG	LBS
MG-944	108	384	235	42	151	92	444	979



LAT PULLDOWN / LOW ROW

Dual function with a space-saving design • High pads easily adjust to provide stability and comfort • Available as a freestanding unit (MG-FS946)

	PRODUCT DIMENSIONS (L X W X H)						PRODUCT WEIGHT	
	CM			INCHES			KG	LBS
MG-946	198	69	234	78	27	92	215	475



BICEPS / TRICEPS

Dual grips for added exercise variety • Dual function with a space-saving design • Available as a freestanding unit (MG-FS947)

	PRODUCT DIMENSIONS (L X W X H)						PRODUCT WEIGHT	
	CM			INCHES			KG	LBS
MG-947	107	117	234	42	46	92	170	375



ADJUSTABLE PULLEY

Unique lower handles support wheelchair users • Cable column adjusts to provide exercise variety with 17 positions • Wheelchair accessible

	PRODUCT DIMENSIONS (L X W X H)						PRODUCT WEIGHT	
	CM			INCHES			KG	LBS
MG-ADA23	79	69	218	31	27	86	155	342



CHEST PRESS / ROW

Direct roll-in wheelchair design • Chest pad easily rotates to switch between exercises • Dual function for added exercise variety • Wheelchair accessible

	PRODUCT DIMENSIONS (L X W X H)						PRODUCT WEIGHT	
	CM			INCHES			KG	LBS
MG-ADA2220	117	99	218	46	39	86	231	510



BICEPS / LAT PULLDOWN

Gas-assisted arm pad for ease of use • Elbow pads help alleviate shoulder stress and provide greater stability and comfort • Dual function for added exercise variety • Wheelchair accessible

	PRODUCT DIMENSIONS (L X W X H)						PRODUCT WEIGHT	
	CM			INCHES			KG	LBS
MG-ADA1121	132	74	218	52	29	86	242	534



PEC DECK

Direct roll-in wheelchair design • Oversized arm pads eliminate need for adjustments • Wheelchair accessible

	PRODUCT DIMENSIONS (L X W X H)						PRODUCT WEIGHT	
	CM			INCHES			KG	LBS
MG-ADA18	81	102	218	32	40	86	189	416

BREAKER BENCHES /

EASIER TAKEOFFS

Incredibly beneficial for beginners and professional athletes alike, this exclusive system uses pivoting uprights to place the bar directly over the user. We call them Breaker Benches because they eliminate the need for assistance to break the bar, allowing users to get into the start position with less stress on their joints. Greater comfort, easier takeoffs and increased efficiency add up to a superior solution for all users in resistance training.



BREAKER OLYMPIC FLAT BENCH



Uprights pivot forward into ideal starting position, directly over the user for easy takeoff • Molded urethane guards protect Olympic bars from damage, reduce noise and provide a hand rest for spotters • Wide back pad stabilizes users during heavy lifts • 10 weight-storage horns (20-kg / 45-lb. plates store at waist height) • Designed to meet EN957 and ASTM safety standards • Shown with optional spotter platform (MG-AOSP)

	PRODUCT DIMENSIONS (L X W X H)						PRODUCT WEIGHT	
	CM		INCHES				KG	LBS
MG-A678	173	168	130	68	66	51	94	207

OLYMPIC FLAT BENCH



Molded urethane guards protect Olympic bars from damage, reduce noise and provide a hand rest for spotters • Wide back pad stabilizes users during heavy lifts • 10 weight-storage horns (20-kg / 45-lb. plates store at waist height) • Designed to meet EN957 and ASTM safety standards • Shown with optional spotter platform (MG-AOSP)

	PRODUCT DIMENSIONS (L X W X H)						PRODUCT WEIGHT	
	CM		INCHES				KG	LBS
MG-A78	163	168	130	64	66	51	73	160

BREAKER OLYMPIC INCLINE BENCH



Uprights pivot forward into ideal starting position, directly over the user for easy takeoff • Molded urethane guards protect Olympic bars from damage, reduce noise and provide a hand rest for spotters • Wide back pad stabilizes users during heavy lifts • Ratcheting seat design for ease of use and adjustment • 10 weight-storage horns (20-kg / 45-lb. plates store at waist height) • Comes standard with built-in spotter platform • Designed to meet EN957 and ASTM safety standards

	PRODUCT DIMENSIONS (L X W X H)						PRODUCT WEIGHT	
	CM		INCHES				KG	LBS
MG-A679	170	168	160	67	66	63	126	277

OLYMPIC INCLINE BENCH



Molded urethane guards protect Olympic bars from damage, reduce noise and provide a hand rest for spotters • Wide back pad stabilizes users during heavy lifts • Ratcheting seat design for ease of use and adjustment • 10 weight-storage horns (20-kg / 45-lb. plates store at waist height) • Comes standard with built-in spotter platform • Designed to meet EN957 and ASTM safety standards

	PRODUCT DIMENSIONS (L X W X H)						PRODUCT WEIGHT	
	CM		INCHES				KG	LBS
MG-A79	170	168	160	67	66	63	107	235



BREAKER OLYMPIC DECLINE BENCH

Uprights pivot forward into ideal starting position, directly over the user for easy takeoff • Molded urethane guards protect Olympic bars from damage, reduce noise and provide a hand rest for spotters • 10 weight-storage horns (20-kg / 45-lb. plates store at waist height) • Wide back pad stabilizes users during heavy lifts • Designed to meet EN957 and ASTM safety standards • Knee and ankle pads easily pivot to accommodate all user sizes

	PRODUCT DIMENSIONS (L X W X H)						PRODUCT WEIGHT	
	CM		INCHES				KG	LBS
MG-A680	206	168	135	81	66	53	107	235



OLYMPIC DECLINE BENCH

Molded urethane guards protect Olympic bars from damage, reduce noise and provide a hand rest for spotters • 10 weight-storage horns (20-kg / 45-lb. plates store at waist height) • Wide back pad stabilizes users during heavy lifts • Designed to meet EN957 and ASTM safety standards • Knee and ankle pads easily pivot to accommodate all user sizes

	PRODUCT DIMENSIONS (L X W X H)						PRODUCT WEIGHT	
	CM		INCHES				KG	LBS
MG-A80	201	168	137	79	66	54	82	180



BREAKER OLYMPIC SHOULDER BENCH

Uprights pivot forward into ideal starting position, directly over the user for easy takeoff • Molded urethane guards protect Olympic bars from damage, reduce noise and provide a hand rest for spotters • Comes standard with built-in spotter platform • 10 weight-storage horns (20-kg / 45-lb. plates store at waist height) • Designed to meet EN957 and ASTM safety standards

	PRODUCT DIMENSIONS (L X W X H)						PRODUCT WEIGHT	
	CM		INCHES				KG	LBS
MG-A645	135	138	183	53	66	72	118	260



OLYMPIC SHOULDER BENCH

Front and rear takeoffs connected with bottom stop bar • Molded urethane guards protect Olympic bars from damage, reduce noise and provide a hand rest for spotters • Comes standard with built-in spotter platform • 10 weight-storage horns (20-kg / 45-lb. plates store at waist height) • Designed to meet EN957 and ASTM safety standards

	PRODUCT DIMENSIONS (L X W X H)						PRODUCT WEIGHT	
	CM		INCHES				KG	LBS
MG-A45	127	138	165	50	66	65	137	303



3-WAY OLYMPIC BENCH

Molded urethane guards protect Olympic bars from damage, reduce noise and provide a hand rest for spotters • Flat bench press, incline press and shoulder press can all be performed with simple adjustments • Easy-to-use seat automatically moves into proper position when back is adjusted • 10 weight-storage horns hold over 454 kg / 1000 lbs. of Olympic plates • Designed to meet EN957 and ASTM safety standards

	PRODUCT DIMENSIONS (L X W X H)						PRODUCT WEIGHT	
	CM		INCHES				KG	LBS
MG-C895	167	180	173	71	66	68	155	342



MULTI-ADJUSTABLE BENCH LP

Seat automatically adjusts with the back pad for ease of use • Adjustable back pad with 8 positions from 0 to 75 degrees • Tapered wide back pad stabilizes users during heavy lifts • Molded guards protect high wear / scuff areas • Transport handle and integrated wheels simplify movement within facility • Low 17.8" floor-to-pad height minimizes lower back stress and prevents arching

	PRODUCT DIMENSIONS (L X W X H)						PRODUCT WEIGHT	
	CM			INCHES			KG	LBS
MG-A82	152	78	46	59.7	30.6	17.8	55	121.5



MULTI-ADJUSTABLE BENCH

Seat automatically adjusts with the back pad for ease of use • Adjustable back pad with 5 positions from 0 to 80 degrees • Wide back pad stabilizes users during heavy lifts • Molded guards protect high wear / scuff areas • Drop-away handle and integrated wheels simplify movement within facility

	PRODUCT DIMENSIONS (L X W X H)						PRODUCT WEIGHT	
	CM			INCHES			KG	LBS
MG-A85	135	58	51	53	23	20	43	95



FLAT BENCH

Single cross leg provides more freedom for users • Wide back pad stabilizes users during heavy lifts • Molded guards protect high wear / scuff areas • Integrated wheels simplify movement within facility

	PRODUCT DIMENSIONS (L X W X H)						PRODUCT WEIGHT	
	CM			INCHES			KG	LBS
MG-A59	142	58	46	56	23	18	25	55



MULTI-ADJUSTABLE BENCH W/DECLINE

Backrest adjusts into 7 positions — decline: -10 and 2.5 degrees; incline: 17.5, 32, 48, 64.5 and 87.5 degrees • Wide back pad stabilizes users during heavy lifts • Molded guards protect high wear / scuff areas • Leg pads provide added stability • Integrated wheels simplify movement within facility

	PRODUCT DIMENSIONS (L X W X H)						PRODUCT WEIGHT	
	CM			INCHES			KG	LBS
MG-A86	166	60.5	53.5	65.3	23.8	21	62	137



UTILITY BENCH

Oversized foot supports provide maximum stability • Molded guards protect high wear / scuff areas • Oversized rubber foot platforms provide added stability • Integrated wheels simplify movement within facility

	PRODUCT DIMENSIONS (L X W X H)						PRODUCT WEIGHT	
	CM		INCHES				KG	LBS
MG-A87	142	66	89	56	26	35	31	68



ADJUSTABLE DECLINE BENCH

9 adjustments from 10 to 30 degrees • Gas-assist for easy adjustment • Wide back pad stabilizes users during heavy lifts • Molded guards protect high wear / scuff areas • Integrated wheels for easy transport

	PRODUCT DIMENSIONS (L X W X H)						PRODUCT WEIGHT	
	CM		INCHES				KG	LBS
MG-A61	163	64	81	64	25	32	45	99



ADJUSTABLE AB BENCH

Adjustable leg pad accommodates all users • Molded guards protect high wear / scuff areas • Back support pivots into 6 different positions from 0 to 25 degrees • Elevated knee position reduces low-back stress

	PRODUCT DIMENSIONS (L X W X H)						PRODUCT WEIGHT	
	CM		INCHES				KG	LBS
MG-A77	155	69	145	61	27	57	59	131



GLUTE HAM BENCH

Step-through design • Leg pads and oversized footplate can be adjusted while in exercise position • Gas-assisted leg pad offers easy vertical adjustment • Handles to perform reverse hyperextensions • Hooks to attach bands for reverse hyperextensions

	PRODUCT DIMENSIONS (L X W X H)						PRODUCT WEIGHT	
	CM		INCHES				KG	LBS
MG-A96	157	91	130	62	36	51	136	300



STANDING ARM CURL

Arm pad height adjusts to accommodate users of all sizes • Durable extruded guards protect frame and bar • Utilizing both sides of the machine increases functionality and saves space

	PRODUCT DIMENSIONS (L X W X H)						PRODUCT WEIGHT	
	CM			INCHES			KG	LBS
MG-A71	119	79	104	47	31	41	61	135



PREACHER CURL

Angled, ratcheting seat encourages proper body positioning • Durable extruded guards protect frame and bar

	PRODUCT DIMENSIONS (L X W X H)						PRODUCT WEIGHT	
	CM			INCHES			KG	LBS
MG-A62	119	76	99	47	30	39	57	125



VKR W/CHIN

Oversized round handles enhance comfort on dip • Angled back support, elbow pads and handles provide added stability and comfort • Multiple chin grips and rock-climbing grips add exercise variety

	PRODUCT DIMENSIONS (L X W X H)						PRODUCT WEIGHT	
	CM			INCHES			KG	LBS
MG-A63C	135	109	245	53	43	96	120	265



SQUAT RACK

Fixed-bottom stops provide added security • Molded urethane guards protect Olympic bars from damage and reduce noise • 5 racking positions and 8 weight-storage horns are standard • Bottom stops can also be used to hold bar for various exercises • Safety Distance from Floor 71.75 cm / 28.25"

	PRODUCT DIMENSIONS (L X W X H)						PRODUCT WEIGHT	
	CM		INCHES				KG	LBS
MG-A81	211.5	166.8	201	83.3	67.5	79.2	265	585



POWER STATION

Adjustable bar stop allows positioning from 30.5" to 48" • Fixed side frame is positioned at 20° for Olympic lifts • Eight racking positions accommodate users for any type of lift • Integrated pull-up bar for increased functionality • Eight standard weight horns hold multiple weight plate sizes

	PRODUCT DIMENSIONS (L X W X H)						PRODUCT WEIGHT	
	CM		INCHES				KG	LBS
MG-A73	185.5	160.4	222.6	73	63.2	87.7	187.2	412.7



BACK EXTENSION BENCH

Large thigh pads and skid-resistant foot platform for enhanced stability • Handles offer easy entry and exit • Molded guards protect high wear / scuff areas • Gas-assist for easy adjustment

	PRODUCT DIMENSIONS (L X W X H)						PRODUCT WEIGHT	
	CM		INCHES				KG	LBS
MG-A52	118.6	76.3	97.3	46.7	30	38.3	53	117



MI BACK TRAINER

Large thigh pads and skid-resistant foot platform for enhanced stability • Handles offer easy entry and exit • Hooks to attach bands for added resistance • 3 different pad adjustment angles (55, 40, 25 degrees)

	PRODUCT DIMENSIONS (L X W X H)						PRODUCT WEIGHT	
	CM		INCHES				KG	LBS
MD-FW52	135.5	73.1	100.1	53.4	28.8	39.4	58	128



BARBELL RACK

Upright design provides convenience for barbell accessories • Rack holds 10 barbells, 5 per side • Chromed pegs provide lasting commercial finish

	PRODUCT DIMENSIONS (L X W X H)						PRODUCT WEIGHT	
	CM			INCHES			KG	LBS
MG-A98	138.5	88.7	152.9	54.5	34.9	60.2	81	178.6



OLYMPIC WEIGHT TREE

9 chrome-plated storage horns for Olympic plates • Rubber bumpers on horns protect frame finish • Ergonomic design positions heavier plates further off the ground for easier removal and replacement

	PRODUCT DIMENSIONS (L X W X H)						PRODUCT WEIGHT	
	CM			INCHES			KG	LBS
MG-A94	87.1	57	107.9	34.3	22.5	42.5	28.8	63.5



WEIGHT TREE W/BAR HOLDERS

6 chromed storage horns, 2 of which accommodate 20-kg / 45-lb. plates • 2 vertical bar holders for Olympic or curl bar storage • Rubber bumpers on horns protect frame finish

	PRODUCT DIMENSIONS (L X W X H)						PRODUCT WEIGHT	
	CM			INCHES			KG	LBS
MG-A67B	51	52	112	20	21	44	23	50



ACCESSORY RACK

Facilitates placement of all accessories in one spot for convenience and a clutter-free facility • Top shelf holds additional accessories

	PRODUCT DIMENSIONS (L X W X H)						PRODUCT WEIGHT	
	CM			INCHES			KG	LBS
MG-A97	110.1	69.4	110.5	43.4	27.4	43.5	47.6	105



STEP-UP PLATFORM W/HANDLE

20 cm / 8" step-up height • Non-slip surface

	PRODUCT DIMENSIONS (L X W X H)						PRODUCT WEIGHT	
	CM			INCHES			KG	LBS
MG-SUP	95	48	122.5	37.5	19	48.25	34	75



SPOTTER PLATFORM

Wide-tapered rubber platform provides additional leverage for heavy lifting • Available as an option on the MG-A78 and MG-A678 Olympic Flat Benches • Standard on the Olympic Incline and Shoulder Press Benches

	PRODUCT DIMENSIONS (L X W X H)						PRODUCT WEIGHT	
	CM			INCHES			KG	LBS
MG-A0SP	66	84	29	26	33	12	28	61

5-PAIR PRO-STYLE DUMBBELL RACK



Storage space for 5 pairs of pro-style dumbbells up to 68 kg / 150 lbs. • 15-degree angled tray helps prevent wrist strain when removing and replacing dumbbells • Cradles hold dumbbells securely in place to prevent rolling pinch hazards

	PRODUCT DIMENSIONS (L X W X H)						PRODUCT WEIGHT	
	CM		INCHES				KG	LBS
MG-A505	232.6	61.3	79.8	91.6	24.2	31.5	63	138.6

10-PAIR PRO-STYLE DUMBBELL RACK



Storage space for 10 pairs of pro-style dumbbells up to 68 kg / 150 lbs. • 15-degree angled trays help prevent wrist strain when removing and replacing dumbbells • Cradles hold dumbbells securely in place to prevent rolling pinch hazards

	PRODUCT DIMENSIONS (L X W X H)						PRODUCT WEIGHT	
	CM		INCHES				KG	LBS
MG-A510	232.6	61.3	79.8	91.6	24.2	31.5	106	233.2

15-PAIR PRO-STYLE DUMBBELL RACK



Storage space for 15 pairs of pro-style dumbbells up to 68 kg / 150 lbs. • 15-degree angled trays help prevent wrist strain when removing and replacing dumbbells • Cradles hold dumbbells securely in place to prevent rolling pinch hazards

	PRODUCT DIMENSIONS (L X W X H)						PRODUCT WEIGHT	
	CM		INCHES				KG	LBS
MG-A515	232.6	67.3	102.1	91.6	26.5	40.2	156	343.2

2-TIER FLAT-TRAY DUMBBELL RACK



231 cm / 91" rack holds hex head dumbbells weighing up to 52 kg / 115 lbs. • Also available: 185 cm / 73", 2-tier Flat-tray Dumbbell Rack (MG-A526)

	PRODUCT DIMENSIONS (L X W X H)						PRODUCT WEIGHT	
	CM		INCHES				KG	LBS
MG-A528	232.2	62.5	79.4	91.5	24.6	31.3	127	279.4
MG-A526	186.2	62.5	79.4	73.3	24.6	31.3	108	237.6

3-TIER FLAT-TRAY DUMBBELL RACK



231 cm / 91" rack holds hex head dumbbells weighing up to 52 kg / 115 lbs. • Also available: 185 cm / 73", 3-tier Flat-tray Dumbbell Rack (MG-A536)

	PRODUCT DIMENSIONS (L X W X H)						PRODUCT WEIGHT	
	CM		INCHES				KG	LBS
MG-A538	232.2	72.4	101.8	91.5	28.5	40	193	424.6
MG-A536	186.2	72.4	101.8	73.3	28.5	40	160	352

STUDIO PRO-STYLE DUMBBELL RACK



Storage space for 10 pairs of pro-style dumbbells from 2-20 kg / 5-50 lbs. • 15-degree angled trays help prevent wrist strain when removing and replacing dumbbells • Space-saving design minimizes footprint and uses less space than traditional 10-pair 2-tier rack • Cradles hold dumbbells securely in place to prevent rolling pinch hazards

	PRODUCT DIMENSIONS (L X W X H)						PRODUCT WEIGHT	
	CM		INCHES				KG	LBS
MG-A541	186.2	67.3	102.1	73.3	26.5	40.2	123	270.6

STUDIO FLAT-TRAY DUMBBELL RACK



122 cm / 48" rack holds 2-20 kg / 5-50 lb. hex head dumbbells

	PRODUCT DIMENSIONS (L X W X H)						PRODUCT WEIGHT	
	CM		INCHES				KG	LBS
MG-A544	123.2	72.4	101.8	48.5	28.5	39.4	118	259.6

AVAILABLE OPTIONS:

DECAL SHEET

MG-AODS, weight decal sheet allows a facility to label where weights are to be stored; decals range from 2.5-60 (lbs./kg) in increments of 2.5, and 65-150 (lbs./kg) in increments of 5.

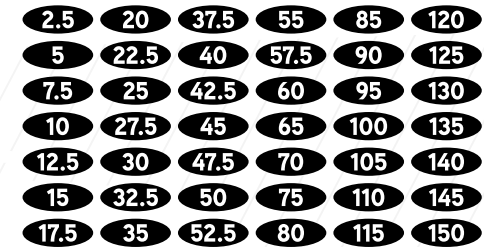

KETTLEBELL RACK ADAPTERS

Adapters can be added to flat-tray dumbbell racks for kettlebell storage

GLUTE TRAINER /

SMART & STABLE

Help athletes tone muscle, build power, and improve hip and core stability with a smarter, more stable take on high-intensity glute training. Advanced biomechanics mimic bar hip thrusting without the difficulty and discomfort of free weights, and walk-through design makes it easy for anyone to get started. Refined ergonomics accommodate users of all sizes comfortably, while high maximum resistance and elastic band hooks challenge even elite athletes.

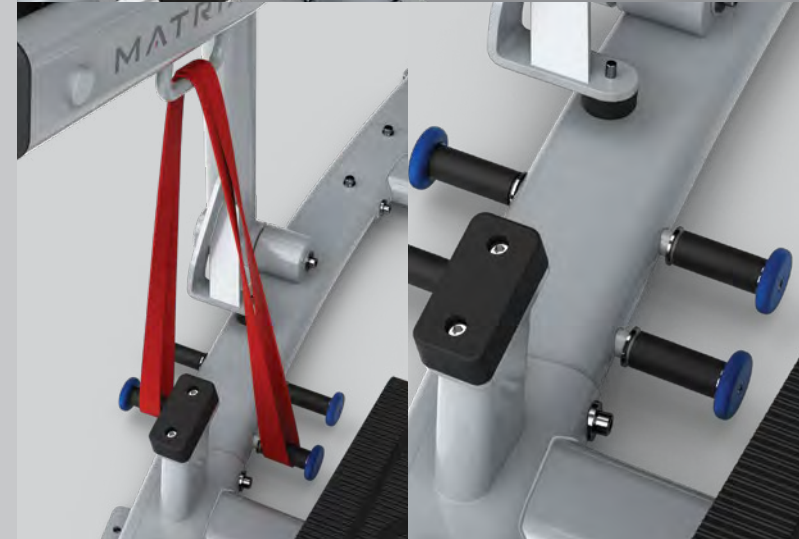





VERTICAL BENCH PRESS

Independent converging movement provides a natural path of motion • Back pad adjusts to alter range of motion and expand training options • Dual-grip pressing positions offer greater training variety • Ratcheting seat for easy adjustment • 4 integrated weight-storage horns

	PRODUCT DIMENSIONS (L X W X H)						PRODUCT WEIGHT	
	CM		INCHES				KG	LBS
MG-PL12	146.5	168.5	199.5	58.0	66.5	78.5	196	432



SUPINE BENCH PRESS

Independent converging movement provides a natural path of motion • Dual-grip pressing positions offer greater training variety • 2 integrated weight-storage horns

	PRODUCT DIMENSIONS (L X W X H)						PRODUCT WEIGHT	
	CM		INCHES				KG	LBS
MG-PL13	185.4	128.3	91.4	73.0	50.5	36.0	98	216



INCLINE BENCH PRESS

Independent converging movement provides a natural path of motion • Back pad adjusts to alter range of motion and expand training options • Dual-grip pressing positions offer greater training variety • Ratcheting seat for easy adjustment • 4 integrated weight-storage horns

	PRODUCT DIMENSIONS (L X W X H)						PRODUCT WEIGHT	
	CM		INCHES				KG	LBS
MG-PL14	208.2	143.2	129.6	82	56.5	51	147.5	325



VERTICAL DECLINE BENCH PRESS

Independent converging movement provides a natural path of motion • Back pad adjusts to alter range of motion and expand training options • Dual-grip pressing positions offer greater training variety • Ratcheting seat for easy adjustment • 4 integrated weight-storage horns

	PRODUCT DIMENSIONS (L X W X H)						PRODUCT WEIGHT	
	CM		INCHES				KG	LBS
MG-PL15	148	168.5	195	58.5	66.5	77	195.5	431



SHOULDER PRESS

Independent converging movement provides a natural path of motion • Slightly reclined position reduces lower back strain • Dual-grip pressing positions offer greater training variety • Ratcheting seat for easy adjustment • 4 integrated weight-storage horns

	PRODUCT DIMENSIONS (L X W X H)						PRODUCT WEIGHT	
	CM			INCHES			KG	LBS
MG-PL23	161.3	160	118.1	63.5	63	46.5	118	260



LAT PULLDOWN

Diverging independent arms provide a natural path of motion • Easy-to-use thigh-pad adjustment for proper support • Angled seat cues optimal user position • 2 integrated weight-storage horns

	PRODUCT DIMENSIONS (L X W X H)						PRODUCT WEIGHT	
	CM			INCHES			KG	LBS
MG-PL33	182.9	123.2	190.5	72	48.5	75	128	282



SEATED ROW

Diverging independent arms provide a natural path of motion • Dual-grip positions offer greater training variety • Two different foot positions accommodate a greater variety of user heights • Ratcheting seat for easy adjustment • Integrated weight-storage horn

	PRODUCT DIMENSIONS (L X W X H)						PRODUCT WEIGHT	
	CM			INCHES			KG	LBS
MG-PL34	152.4	139.7	106.7	60	55	42	118	260



AB CRUNCH BENCH

Dual supported pivot for added strength and performance • Lower step-through height for easy entry and exit • Dual-action pivot for natural biomechanics • Angled handles enhance shoulder comfort and feel • Center tube supports heavier individuals • Weight horn accommodates 12-kg / 25-lb. plates for advanced users

	PRODUCT DIMENSIONS (L X W X H)						PRODUCT WEIGHT	
	CM			INCHES			KG	LBS
MG-PL50	162.6	88.9	100.3	64	35	39.5	60	132.5



SMITH MACHINE

Counter balanced 11.3-kg / 25-lb. bar takeoff for low starting resistance • Features a 90-degree path of motion adapts to all exercises • Linear bearings provide a smooth motion • Non-removable safety stops add training security • 8 integrated weight-storage horns hold multiple weight-plate sizes

	PRODUCT DIMENSIONS (L X W X H)						PRODUCT WEIGHT	
	CM	INCHES		CM	INCHES		KG	LBS
MG-PL62	110.5	231.1	245.1	43.5	91	96.5	270	569

45° LEG PRESS



Easy-to-use and see racking mechanism • Adjustable bottom stops provide long or short ranges of motion for all user heights • Adjustable angle back pad enhances comfort, optimizes hip angles and accommodates a greater range of users • Assistance handle on platform for easier entry and exit • Linear bearings for smooth feel and function • 4 integrated weight-storage horns hold multiple weight-plate sizes

	PRODUCT DIMENSIONS (L X W X H)						PRODUCT WEIGHT	
	CM		INCHES				KG	LBS
MG-PL70	229	171	158	90	67.5	62.3	274	604

GLUTE TRAINER



Comfortable user positioning and efficient machine layout mimic bar hip thrusting without the hassle of unwieldy free weights • Walk-through design with swiveling hip pad provides easy entry and exit • Maximum resistance of 227 kg / 500 lbs. • Integrated dual-sided band hooks provide elastic resistance for explosiveness training and movement variety • Floating hip pad adjusts to fit users of all sizes and comfortable feel • Large, angled foot platform with non-slip surface offers excellent stability to better engage glutes • Oversized shoulder pad provides comfortable torso support

	PRODUCT DIMENSIONS (L X W X H)						PRODUCT WEIGHT	
	CM		INCHES				KG	LBS
MG-PL78	168	133	109	66.5	52.5	43	154	340

HACK SQUAT



Large footplate and back pad accommodate users of all sizes • Spring-loaded take off handles for ease of use and engagement • Adjustable bottom stops provide long or short ranges of motion for all user heights • 4 integrated weight-storage horns

	PRODUCT DIMENSIONS (L X W X H)						PRODUCT WEIGHT	
	CM		INCHES				KG	LBS
MG-PL71	228.2	150	144.6	90	59	57	270	595

SQUAT / LUNGE



Independent lifting arms for balanced exercise and exercise variation • Multiple hand-grip positions offer greater training variety • 3 integrated weight-storage horns keep weight plates in close proximity • 4 user weight horns provide maximal loading for strong users

	PRODUCT DIMENSIONS (L X W X H)						PRODUCT WEIGHT	
	CM		INCHES				KG	LBS
MG-PL79	148.6	170.2	86.4	58.5	67	34	120	264.5



STANDING CALF

Adjustable height shoulder pads accommodate users of all sizes • Angled footplate provides superior grip and improves calf recruitment • Angled support handles enhance comfort

	PRODUCT DIMENSIONS (L X W X H)						PRODUCT WEIGHT	
	CM			INCHES			KG	LBS
MG-PL76	138	89	184.5	54.5	35	73	124	273.5



4-WAY NECK

Counterbalanced arm for optimal starting resistance • Counterweighted pivoting head pads enhance comfort • Adjustable seat and 4 handles provide comfortable user positioning • 2 weight-storage horns

	PRODUCT DIMENSIONS (L X W X H)						PRODUCT WEIGHT	
	CM			INCHES			KG	LBS
MG-404	84	147	165	33	58	65	79	175



SEATED CALF

Seat moves with input arm to maintain alignment • Curved and angled foot pad improves comfort and calf recruitment • Quick-release bar catch simplifies operation • Knee pads adjust for tibia length and range of motion

	PRODUCT DIMENSIONS (L X W X H)						PRODUCT WEIGHT	
	CM			INCHES			KG	LBS
MG-PL77	141	80	96.5	55.5	31.5	38	65	143.5



REVERSE BACK EXTENSION

Adjustable starting point to select desired range of motion • Leg pad can be locked in forward position to use without resistance • Dual hand grips provide added variety and comfort • 2 weight-storage horns

	PRODUCT DIMENSIONS (L X W X H)						PRODUCT WEIGHT	
	CM			INCHES			KG	LBS
MG-405	150	109	145	59	43	57	134	295



DOUBLE MEGA RACK CONFIGURATION

It doesn't get any bigger than this. Matrix Double MEGA Racks take your training to the max. A combination of two racks and custom connecting elements, the Double MEGA Rack allows you to tailor your equipment to your facility. This flexibility enables you to define your own priorities and get the most out of your investment each and every training day. Plus, the Matrix 7-gauge steel uprights and heavy-duty frames mean the Double MEGA Rack can simultaneously handle your toughest athletes and your most rigorous workouts. Maximize your space and your athletes at the same time with the Double MEGA Rack.

** Shown with optional accessories.*







MEGA POWER RACK

Fully enclosed style offers ideal spotting abilities • Shown with adjustable safety bars, dual-grip chin bar, bar storage, band storage and weight storage • J-hooks made of high-density polyethylene (HDPE) to protect Olympic bars from scratches • Visual height indicator and colored locking pin make bar-level changes quick and easy • 3 retractable lower-band pegs on each side (6 total) • Also available in 9' height

	PRODUCT DIMENSIONS (L X W X H)						PRODUCT WEIGHT	
	CM		INCHES				KG	LBS
MG-MR47	206	207	246.5	81	81.5	97	347	765



MEGA HALF RACK

Open-front design gives users freedom of movement • Shown with adjustable safety bars, dual-grip chin bar, bar storage, band storage and weight storage • J-hooks made of high-density polyethylene (HDPE) to protect Olympic bars from scratches • Visual height indicator and colored locking pin make bar-level changes quick and easy • 3 retractable lower-band pegs on each side (6 total) • Also available in 9' height

	PRODUCT DIMENSIONS (L X W X H)						PRODUCT WEIGHT	
	CM		INCHES				KG	LBS
MG-MR690	170.5	207	246.5	67	81.5	97	259	570



MEGA OPEN RACK

Designed for a variety of lifts — presses, squats, overhead lifts and more • Shown with adjustable safety bars, dual-grip chin bars, bar storage, band storage and weight storage • J-hooks made of high-density polyethylene (HDPE) to protect Olympic bars from scratches • Visual height indicator and colored locking pin make bar-level changes quick and easy • 3 retractable lower-band pegs on each side (6 total) • Also available in 9' height

	PRODUCT DIMENSIONS (L X W X H)						PRODUCT WEIGHT	
	CM		INCHES				KG	LBS
MG-MR694	206	207	246.5	81	81.5	97	249.5	550



MEGA DOUBLE HALF RACK

Designed for training efficiency • Shown with 2 sets of adjustable safety bars, dual-grip chin bars, bar storage, band storage and weight storage • J-hooks made of high-density polyethylene (HDPE) to protect Olympic bars from scratches • Visual height indicator and colored locking pin make bar-level changes quick and easy • 3 retractable lower-band pegs on each side per half rack (12 total)

	PRODUCT DIMENSIONS (L X W X H)						PRODUCT WEIGHT	
	CM		INCHES				KG	LBS
MG-MR691	314	207	246.5	123.5	81.5	97	542	1195



POWER RACK

Fully enclosed style offers ideal spotting abilities • Shown with adjustable safety bars, chin bars, bar storage, band storage and weight storage • J-hooks made of high-density polyethylene (HDPE) to protect Olympic bars from scratches • Visual height indicator and colored locking pin make bar-level changes quick and easy • Also available in 7'6" (-LH) and 9' (-9) heights.

	PRODUCT DIMENSIONS (L X W X H)						PRODUCT WEIGHT	
	CM	INCHES		KG	LBS			
MG-A47	204.5	187	256.5	80.5	73.5	101	268	590



HALF RACK

Open-front design gives users freedom of movement • Shown with adjustable safety bars, chin bars, bar storage, band storage and weight storage • J-hooks made of high-density polyethylene (HDPE) to protect Olympic bars from scratches • Visual height indicator and colored locking pin make bar-level changes quick and easy • Also available in 7'6" (-LH) and 9' (-9) heights.

	PRODUCT DIMENSIONS (L X W X H)						PRODUCT WEIGHT	
	CM	INCHES		KG	LBS			
MG-A690	166.5	187	256.5	65.5	73.5	101	195	430



OPEN RACK

Designed for a variety of lifts — presses, squats, overhead lifts and more • Shown with adjustable safety bars, chin bars, bar storage, band storage and weight storage • J-hooks made of high-density polyethylene (HDPE) to protect Olympic bars from scratches • Visual height indicator and colored locking pin make bar-level changes quick and easy • Also available in 9' (-9) heights.

	PRODUCT DIMENSIONS (L X W X H)						PRODUCT WEIGHT	
	CM	INCHES		KG	LBS			
MG-A694	204.5	187	256.5	80.5	73.5	101	234	515



DOUBLE HALF RACK

Designed for training efficiency • Shown with 2 sets of adjustable safety bars, chin bars, bar storage, band storage and weight storage • J-hooks made of high-density polyethylene (HDPE) to protect Olympic bars from scratches • Visual height indicator and colored locking pin make bar-level changes quick and easy • Also available in 9' (-9) heights

	PRODUCT DIMENSIONS (L X W X H)						PRODUCT WEIGHT	
	CM		INCHES				KG	LBS
MG-A691	306	204.5	265.5	120.5	80.5	101	420	925



COMPACT DOUBLE HALF RACK

Designed for training and space efficiency • Shown with adjustable safety bars & j-hooks, dual-straight chin bars, bar storage, band storage and weight storage • J-hooks made of high-density polyethylene (HDPE) to protect bar knurling from scratches • Visual height indicator and colored locking pin make bar-level changes quick and easy

	PRODUCT DIMENSIONS (L X W X H)						PRODUCT WEIGHT	
	CM		INCHES				KG	LBS
MG-A691S	197.5	186	256.5	77.75	73.25	101	297	655



COMBO POWER HALF RACK

Combined rack design allows for various open- and closed- training environments • Shown with 2 sets of adjustable safety bars, chin bars, bar storage, band storage and weight storage • J-hooks made of high-density polyethylene (HDPE) to protect Olympic bars from scratches • Visual height indicator and colored locking pin make bar-level changes quick and easy • Also available in 7'6" (-LH) and 9' (-R) heights

	PRODUCT DIMENSIONS (L X W X H)						PRODUCT WEIGHT	
	CM		INCHES				KG	LBS
MG-A47691	345.5	204.5	256.5	136	80.5	101	499	1100



* Shown with MR690

LAT PULL DOWN RACK ATTACHMENT

Add selectorized lat pulldown attachment for greater workout versatility in a small space • Angled thigh pads for micro-adjustments to improve stability • Straight bar with angled ends ensures correct arm and wrist position • Add optional Low Row Kit (MG-S21LR) with foldable foot pegs for dual functionality • Add optional shroud decal (MG-OPTSD) to place branded logos

	PRODUCT DIMENSIONS (L X W X H)						PRODUCT WEIGHT		WEIGHT STACK	
	CM		INCHES				KG	LBS	KG	LBS
MG-S21	155	67	247	61	26.5	98	261	576	136.1	300
MG-S23	100	27	250	39.5	10.5	98	182	402	92.5	204

ADJUSTABLE PULLEY RACK ATTACHMENT

Add selectorized adjustable pulley attachment for greater workout versatility in a small space • 19 different adjustment points maximize functionality • 1:2 pulley ratio offers smooth movement and smaller incremental weight changes • Stainless-steel pulley guards protect paint from damage • Add optional shroud decal (MG-OPTSD) to place branded logos



PRO HALF RACK

Includes adjustable safety arms, j-hooks, straight chin bar, and 4-post chromed bumper plate storage • Open-front design gives users freedom of movement • J-hooks made of high density polyethylene (HDPE) to protect bar knurling from scratches • Also available: MG-PRO690-7 7' Half Rack • Combine with an MG-PRO690C rack to create a combo rack that can use storage shelves and have standard weight horns on the outside

	PRODUCT DIMENSIONS (L X W X H)						PRODUCT WEIGHT	
	CM	INCHES		KG	LBS			
MG-PRO690	183.5	141	243	72.2	55.4	95.5	111	244.5



PRO CONFIGURABLE HALF RACK

Includes adjustable safety arms, j-hooks, and a straight chin bar • J-hooks made of high density polyethylene (HDPE) to protect bar knurling from scratches • Optional chromed weight horns and/or storage shelves can be added to create a variety of storage solutions • Open-front design gives users freedom of movement • Also available: MG-PRO690C-7 7' Configurable Half Rack • Combine with an MG-PRO690 rack to create a combo rack that can use storage shelves and have standard weight horns on the outside

	PRODUCT DIMENSIONS (L X W X H)						PRODUCT WEIGHT	
	CM	INCHES		KG	LBS			
MG-PRO690C	132	141	243	52	55.4	95.5	116.5	257



PRO DOUBLE HALF RACK

Designed for training efficiency • Includes adjustable safety arms, j-hooks, straight chin bars, and 4-post Bumper plate storage • Also available: MG-PRO691-7 7' Double Half Rack • J-hooks made of high density polyethylene (HDPE) to protect bar knurling from scratches • Combine with an MG-PRO691C rack to create a combo rack that can use storage shelves and have standard weight horns on the outside

	PRODUCT DIMENSIONS (L X W X H)						PRODUCT WEIGHT	
	CM	INCHES		KG	LBS			
MG-PRO691	229	183	242.5	90	72	95.5	180	397



PRO CONFIGURABLE DOUBLE HALF RACK

Also available: MG-PRO691C-7 7' Configurable Double Half Rack • Combine with an MG-PRO691 rack to create a combo rack that can use storage shelves and have standard weight horns on the outside • Designed for training efficiency • J-hooks made of high density polyethylene (HDPE) to protect bar knurling from scratches • Optional chromed weight horns and/or storage shelves can be added to create a variety of storage solutions • Includes adjustable safety arms, j-hooks, and straight chin bars

	PRODUCT DIMENSIONS (L X W X H)						PRODUCT WEIGHT	
	CM	INCHES		KG	LBS			
MG-PRO691C	229	132	242.5	90	52	95.5	190	419



6' X 8' PLATFORM W/ HARDWOOD INSERT

Durable rubber training surface to absorb impact, dampen noise and protect flooring during Olympic lifts • Hardwood center insert provides optimum foot grip and stability during explosive Olympic lifts • MA4794P for use with the MR47, A47, MR694, A94 • MA90191P for use with MR690, A690, MR691, A691

	PRODUCT DIMENSIONS (L X W X H)						PRODUCT WEIGHT	
	CM		INCHES				KG	LBS
MA4794P	363	254	7	143	100	2.6	259.5	572
MA90191P	328	254	7	129	100	2.6	250.5	552



4' X 8' PLATFORM W/ HARDWOOD INSERT

Durable rubber training surface to absorb impact, dampen noise and protect flooring during Olympic lifts • Hardwood center insert provides optimum foot grip and stability during explosive Olympic lifts • Options available: • MA4794P for use with the MR47, A47, MR694, A94 • MA90191P for use with MR690, A690, MR691, A691

	PRODUCT DIMENSIONS (L X W X H)						PRODUCT WEIGHT	
	CM		INCHES				KG	LBS
MA4794P-4	305	254	7	120	100	2.6	195.5	431
MA90191P-4	270	254	7	106	100	2.6	186.5	411



STAND-ALONE PLATFORM W/HARDWOOD INSERT

Durable rubber training surface to absorb impact, dampen noise and protect flooring during explosive Olympic lifts • Hardwood center insert provides optimum foot grip and stability during explosive Olympic lifts

	PRODUCT DIMENSIONS (L X W X H)						PRODUCT WEIGHT	
	CM		INCHES				KG	LBS
PS84	131	254	7	51.5	100	2.6	153	337
PS86	191	253	7	75	100	2.6	216.5	477



6' X 8' SOLID RUBBER SURFACE PLATFORM

Durable rubber training surface to absorb impact, dampen noise and protect flooring during Olympic lifts • Options available: MEGA Solid Rubber Surface Platform • MARP4794 for use with MR47, A47, MR694, A694 • MARP9091 for use with MR690, A690, MR691, A691

	PRODUCT DIMENSIONS (L X W X H)						PRODUCT WEIGHT	
	CM		INCHES				KG	LBS
MARP4794	366	254	7	144	100	2.6	292.5	645
MARP9091	330	254	7	130	100	2.6	280	617



4' X 8' SOLID RUBBER SURFACE PLATFORM

Durable rubber training surface to absorb impact, dampen noise and protect flooring during Olympic lifts • Options available: MEGA Solid Rubber Surface Platform (MRP4794) for use with the MR47; MEGA Solid Rubber Surface Platform (MRP9091) for use with the MR690

	PRODUCT DIMENSIONS (L X W X H)						PRODUCT WEIGHT	
	CM		INCHES				KG	LBS
MARP4794-4	305	254	7	120	100	2.6	215.5	475
MARP9091-4	270	254	7	106	100	2.6	203	448



STAND-ALONE SOLID RUBBER PLATFORM

Durable rubber training surface to absorb impact, dampen noise and protect flooring during Olympic lifts

	PRODUCT DIMENSIONS (L X W X H)						PRODUCT WEIGHT	
	CM		INCHES				KG	LBS
RP84	131	254	7	51.5	100	2.6	156	344
RP86	191	253	7	75	100	2.6	233	514



REVERSE J-HOOKS

Made of high-density polyethylene (HDPE) to protect bar knurling • Available in Ridge Black only

	PRODUCT DIMENSIONS (L X W X H)						PRODUCT WEIGHT	
	CM		INCHES				KG	LBS
OPT1R	36	13	25	14	5	10	14	30

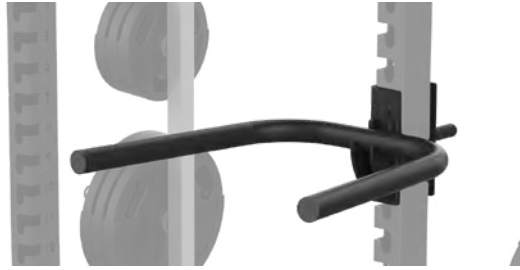

DIP BARS

Attaches to rack uprights for body-weight dips • Also available: Reverse Dip Bars (OPT3R) • Available in Ridge Black only

	PRODUCT DIMENSIONS (L X W X H)						PRODUCT WEIGHT	
	CM		INCHES				KG	LBS
OPT3	86	69	26	34	27	10	16	35



3-PEG BAND PEGS

Band pegs provide added training variety • Available in Ridge Black only

	PRODUCT DIMENSIONS (L X W X H)						PRODUCT WEIGHT	
	CM		INCHES				KG	LBS
OPT4	23	102	6	9	40	2.5	12	26

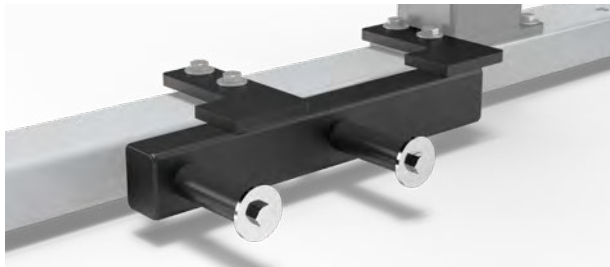

2-PEG BAND PEGS

Band pegs provide added training variety • Available in Ridge Black only

	PRODUCT DIMENSIONS (L X W X H)						PRODUCT WEIGHT	
	CM		INCHES				KG	LBS
OPT5	39	44	7	15	17	2.5	7	14



SQUAT HANDLES

Squat handles can be set at any height on all rack uprights • Available in Ridge Black only

	PRODUCT DIMENSIONS (L X W X H)						PRODUCT WEIGHT	
	CM		INCHES				KG	LBS
OPT6	23	23	13	9	9	5	8	16



STEP-UP PLATFORM

Adjustable height platform provides additional body-weight exercises • Also available: Reverse Step-up Platform (OPT7R) • Available in Ridge Black only

	PRODUCT DIMENSIONS (L X W X H)						PRODUCT WEIGHT	
	CM		INCHES				KG	LBS
OPT7	81	61	36	32	24	14	19	41

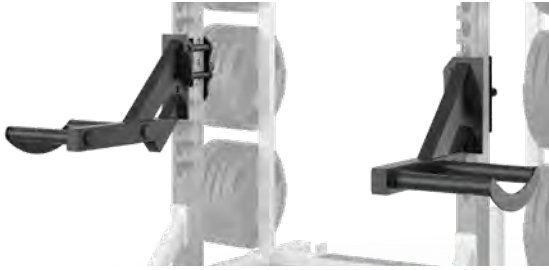

TECHNIQUE SCOOPS

Large cradles accept bumper plates to assist with Olympic lifts and customized takeoff heights • Also available: Reverse Technique Scoops (OPT8R) • Available in Ridge Black only

	PRODUCT DIMENSIONS (L X W X H)						PRODUCT WEIGHT	
	CM			INCHES			KG	LBS
OPT8	66	41	38	26	16	15	39	86



CUSTOM PLATFORM LOGO

Proudly display your facility logo on the platform



PLATFORM RAMP

Ramp allows for gradual incline to rack platforms
• Available in Ridge Black only

	PRODUCT DIMENSIONS (L X W X H)						PRODUCT WEIGHT	
	CM			INCHES			KG	LBS
OPT11	14.5	107	6.5	5.7	42	2.5	6	13.2



LAND MINE ATTACHMENT

Attaches to any A series rack for rotational training (bar not included) • Also available: Mega Rack Landmine Attachment (MOPT13) • Available in Ridge Black only

	PRODUCT DIMENSIONS (L X W X H)						PRODUCT WEIGHT	
	CM			INCHES			KG	LBS
OPT13	64	21.1	19.1	25.2	8.3	7.5	8.4	18.4



NAMEPLATE

Proudly display your logo above your rack



CORE HANDLE

Used with an Olympic bar and Land Mine Attachment for added training variety • Available in Ridge Black only

	PRODUCT DIMENSIONS (L X W X H)						PRODUCT WEIGHT	
	CM			INCHES			KG	LBS
OPT14U	102	1	20	40	.25	8	2	15

	PRODUCT DIMENSIONS (L X W X H)						PRODUCT WEIGHT	
	CM			INCHES			KG	LBS
OPT16	48	79	5	19	31	2	5	10

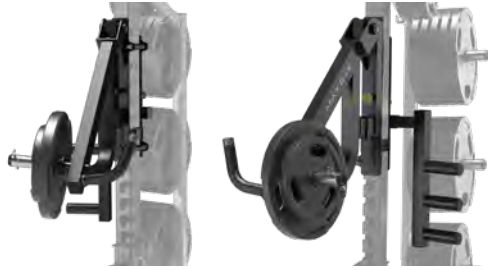

JAMMIN ARMS W/BAND ATTACHMENT

Angled pressing arms with band attachments for added training variety with speed and resistance

- Also available: Reverse Jammin Arms w/ Band Attachment (OPT17RB)

	PRODUCT DIMENSIONS (L X W X H)						PRODUCT WEIGHT	
	CM			INCHES			KG	LBS
OPT17B	107	56	96	42	22	37.5	64	140



SAFETY ARM STORAGE

Bolt-on storage for safety arms provides easy access to arms when not in use • Also available: Safety Arm Storage (OPT21) for A series racks
• Available in Ridge Black only

	PRODUCT DIMENSIONS (L X W X H)						PRODUCT WEIGHT	
	CM			INCHES			KG	LBS
OPT22	23	21	9	9	8	3.5	2	4



FAT BAR J-HOOKS

Made of high-density polyethylene (HDPE) to protect bar knurling • Oversized hooks accommodate large-diameter Olympic bars • Also available: Reverse Fat Bar J-hooks (OPT26R) • Available in Ridge Black only

	PRODUCT DIMENSIONS (L X W X H)						PRODUCT WEIGHT	
	CM			INCHES			KG	LBS
OPT26	47	18	34	19	4	13	16	35



DOCKING KIT W/NO PLATFORM

Connects MG-A695 Flat-to-incline Bench w/ Horizontal Adjustment directly to racks without a platform
• Available in Ridge Black only

	PRODUCT DIMENSIONS (L X W X H)						PRODUCT WEIGHT	
	CM			INCHES			KG	LBS
OPT29	23	3	12	9	1	4.5	3	5



DOCKING KIT W/PLATFORM

Connects MG-A695 Flat-to-incline Bench w/ Horizontal Adjustment directly to racks when using a platform • Available in Ridge Black only

	PRODUCT DIMENSIONS (L X W X H)						PRODUCT WEIGHT	
	CM			INCHES			KG	LBS
OPT29P	23	3	7	9	1	2.5	2	3



BATTLE ROPE ATTACHMENT

For rope training as an anchor point on any rack • Also available: Mega Rack Battle Rope attachment (MOPT31) • Available in Chrome finish only

	PRODUCT DIMENSIONS (L X W X H)						PRODUCT WEIGHT	
	CM		INCHES				KG	LBS
OPT31	18	23	17	7	9	7	4	7



STRAIGHT LADDER

Horizontal ladder connecting power racks together for bodyweight training • For use on the MR47, A47, A47691 • Also available: Straight Ladder Connecting Bracket in both 244 cm / 8' (OPT32-8) and 297 cm / 9'9" (OPT32-10) lengths • Available in Matte Black only

	PRODUCT DIMENSIONS (L X W X H)						PRODUCT WEIGHT	
	CM		INCHES				KG	LBS
OPT32-8	243.9	81.2	7.7	96	32	3	42.5	93.6
OPT32-10	297.2	81.2	7.7	117	32	3	51.5	113.2



PYRAMID LADDER

Elevated ladder connecting power racks together for bodyweight training • For use on the MR47, A47, A47691 • Also available: Pyramid Ladder Connecting Bracket in 244 cm / 8' (OPT33-8) and 297 cm / 9'9" (OPT33-10) lengths • Available in Matte Black only

	PRODUCT DIMENSIONS (L X W X H)						PRODUCT WEIGHT	
	CM		INCHES				KG	LBS
OPT33-8	243.9	68.6	51.5	96	27	20.3	44.5	98
OPT33-10	297.2	68.6	53.1	117	27	20.9	53.3	117.2



STRAIGHT CHIN BAR

Pull-up bar connects power racks together for added bodyweight training • Also available: Mega Straight Chin Bar (MOPT35-6, MOPT35-8, MOPT35-10) • Available in Matte Black only

	PRODUCT DIMENSIONS (L X W X H)						PRODUCT WEIGHT	
	CM		INCHES				KG	LBS
OPT35-6	182.9	30.4	7.7	72	12	3	16.8	37
OPT35-8	243.9	30.4	7.7	96	12	3	20.3	44.6
OPT35-10	297.2	30.4	7.7	117	12	3	32.5	71.5



DUAL-SIDED FAT/STRAIGHT CHIN BAR

Multiple grip pull-up bar connects power racks together for added bodyweight training • Also available: Mega Dual-Sided Fat/Straight Chin Bar (MOPT36-6) • Available in Matte Black only

	PRODUCT DIMENSIONS (L X W X H)						PRODUCT WEIGHT	
	CM		INCHES				KG	LBS
OPT36-6	182.9	52.4	9.2	72	20.6	3.6	23.8	52.3



DUAL OLYMPIC BAR STORAGE

Vertical Olympic bar storage • Also available: Mega Dual-Olympic Bar Storage (MOPT41)

	PRODUCT DIMENSIONS (L X W X H)						PRODUCT WEIGHT	
	CM			INCHES			KG	LBS
OPT41	16	110	31	6	43	12	12.7	281



ROTATING CHIN HANDLES

Handles rotate into multiple positions for added exercise variety • Also available: Mega Rotating Chin Handles (MOPT42)

	PRODUCT DIMENSIONS (L X W X H)						PRODUCT WEIGHT	
	CM			INCHES			KG	LBS
OPT42	110	16.5	33	43	6.5	13	11	23



SIDE-MOUNTED PULL-UP BAR

Mounts upward or downward for bodyweight exercises or additional suspension-device exercises • Also available: Mega Side-Mounted Pull-up Bar (MOPT43) • Available in Ridge Black only

	PRODUCT DIMENSIONS (L X W X H)						PRODUCT WEIGHT	
	CM			INCHES			KG	LBS
OPT43	120	22	19	47.25	8.7	7.5	7.25	161

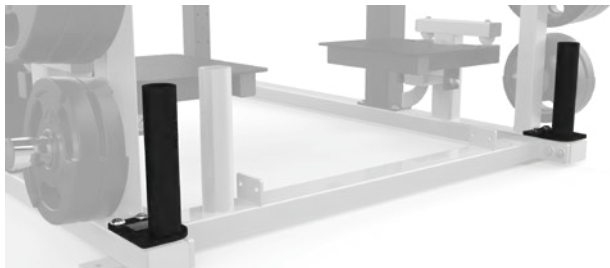

OLYMPIC BAR HOLDERS

Two bolt-on vertical Olympic bar holders • For use on the following racks: A47, A690, A694, A47691 • Available in Ridge Black only

	PRODUCT DIMENSIONS (L X W X H)						PRODUCT WEIGHT	
	CM			INCHES			KG	LBS
OPT44	23.2	10.2	27	9.25	4	10.6	5.7	12.5



BOLT-ON SPOTTER STANDS

Two bolt-on spotter stands • Attaches to any rack • Available in Ridge Black only

	PRODUCT DIMENSIONS (L X W X H)						PRODUCT WEIGHT	
	CM			INCHES			KG	LBS
OPT45	38	81.5	29.5	15	32	11.5	31	68



BOLT-ON FRONT BAND PEG

Two bolt-on upper band pegs for added training variety • Available in Ridge Black only

	PRODUCT DIMENSIONS (L X W X H)						PRODUCT WEIGHT	
	CM			INCHES			KG	LBS
OPT46	28	16	27	11	6.25	10.5	4	9



HORIZONTAL PLATE RACK

Can hold a maximum of 314 kg / 693 lbs. in various weight plate configurations • Includes 1 horn to hold collars, and 1 Olympic bar storage horn • Integrated wheels for easy transport • Available in Ridge Black only

MG-A301	PRODUCT DIMENSIONS (L X W X H)						PRODUCT WEIGHT	
	CM			INCHES			KG	LBS
	160	38.1	43.2	63	15	17	25	55



ATTACHMENT STORAGE RACK

Stores resistance chains and bands; also stores options for your Power Racks, such as dip bars, technique scoops, step-up platforms, etc. • Accessories not included • Available in Ridge Black only

MG-A303	PRODUCT DIMENSIONS (L X W X H)						PRODUCT WEIGHT	
	CM			INCHES			KG	LBS
	122	114	178	48	45	70	73	160



FLAT-TO-INCLINE BENCH W/HORIZONTAL ADJUSTMENT

Locking rods for attachment to power racks • Lever allows user to adjust horizontal length of bench while seated • Seat automatically adjusts to proper angle as the backrest is adjusted • Drop-away handle and wheels provide easy movement • *Optional docking kit required to secure bench to racks

MG-A695	PRODUCT DIMENSIONS (L X W X H)						PRODUCT WEIGHT	
	CM			INCHES			KG	LBS
	137	76	51	54	30	20	64	140

ACCESSORIES /

COMPATIBLE WITH PRO SERIES RACKS ONLY





42" SINGLE CHIN BAR

42" straight chin bar for connecting racks back-to-back • Can be used between the rear uprights of a rack as an added chin bar or as stability ball storage • Available in Matte Black only

	PRODUCT DIMENSIONS (L X W X H)						PRODUCT WEIGHT	
	CM		INCHES				KG	LBS
XR01	107	8	30.5	42	3	12	4.6	10



70" SINGLE CHIN BAR

70" straight chin bar for connecting racks side-to-side or back-to-back • Can be used on the PRO690C 8' half rack only • Available in Matte Black only

	PRODUCT DIMENSIONS (L X W X H)						PRODUCT WEIGHT	
	CM		INCHES				KG	LBS
XR02	86	69	26	34	27	10	16	35



42" PULL-UP STATION

Adds an additional pull-up bar • Works with XR35 for added training variety. If attached to the rear of the rack, or if bands or straps are used, rack must be bolted down • Can be used on the PRO690C 8' half rack only • Available in Matte Black only

	PRODUCT DIMENSIONS (L X W X H)						PRODUCT WEIGHT	
	CM		INCHES				KG	LBS
XT-4-PU	122	81	51	48	31.9	20	17.25	38



PLYO STEP

Adjustable height platform provides additional body-weight exercises • Available in Matte Black only

	PRODUCT DIMENSIONS (L X W X H)						PRODUCT WEIGHT	
	CM		INCHES				KG	LBS
XR13	56	63.5	30.5	22	25	12	17.3	38



HEAVY BAG ATTACHMENT

Boom arm to hold heavy bags or suspension straps • Can be used on the PRO690C 8' half rack only • Rack must be bolted down to use this option • Available in Matte Black only

	PRODUCT DIMENSIONS (L X W X H)						PRODUCT WEIGHT	
	CM		INCHES				KG	LBS
XR14	107	8	48.5	42	3	19	9.1	20



LEG ROLLER ATTACHMENT

Pad allows user to perform multiple single leg exercises • Use with a bench to perform Glute/Ham exercises • Available in Matte Black only

	PRODUCT DIMENSIONS (L X W X H)						PRODUCT WEIGHT	
	CM		INCHES				KG	LBS
XR15	79	23	15.5	31	9	6	7.7	17



ROPE ANCHOR

For rope training as an anchor point
 • Available in Matte Black only

	PRODUCT DIMENSIONS (L X W X H)						PRODUCT WEIGHT	
	CM			INCHES			KG	LBS
XR16	15.5	8	23	6	3	9	1.4	3



DIP-STATION

Used for body-weight dips • Must be used off front of rack, unless rack is bolted down • Available in Matte Black only

	PRODUCT DIMENSIONS (L X W X H)						PRODUCT WEIGHT	
	CM			INCHES			KG	LBS
XR17	66	69	28	26	27	11	13.6	30



BOLT-ON LANDMINE

Used for rotational training • Available in Matte Black only

	PRODUCT DIMENSIONS (L X W X H)						PRODUCT WEIGHT	
	CM			INCHES			KG	LBS
XR18	41	10.5	20.5	16	4	8	3.7	8



BALL TARGET

Used for overhead ball work • Can be used on the PRO690C 8' half rack only • Available in Matte Black only

	PRODUCT DIMENSIONS (L X W X H)						PRODUCT WEIGHT	
	CM			INCHES			KG	LBS
XR22	41	130	6	16	51	2.25	10.9	24



42" NAME PLATE

Display your logo proudly • For use inside of a rack. Note: If used on front uprights it will block the standard chin up bar • Can be used on the PRO690C 8' half rack only • Available in Matte Black only

	PRODUCT DIMENSIONS (L X W X H)						PRODUCT WEIGHT	
	CM			INCHES			KG	LBS
XR25	30.5	119.5	5	12	47	2	5.5	12



70" NAME PLATE

Display your logo proudly between 2 racks • Can be used on the PRO690C 8' half rack only • Available in Matte Black only

	PRODUCT DIMENSIONS (L X W X H)						PRODUCT WEIGHT	
	CM			INCHES			KG	LBS
XR26	30.5	190.5	5	12	75	2	8.7	19



BOLT-ON WEIGHT HORN

Add additional weight storage horns to the upright • Available in Chrome only

	PRODUCT DIMENSIONS (L X W X H)						PRODUCT WEIGHT	
	CM			INCHES			KG	LBS
XR27C	33	8	8	13	3	3	5	11



OLYMPIC BAR HOLDER

Bolt-on Olympic bar holder • Available in Matte Black only

	PRODUCT DIMENSIONS (L X W X H)						PRODUCT WEIGHT	
	CM			INCHES			KG	LBS
XR34	28	20.5	8	11	8	3	2.6	5



UNIVERSAL BAND ATTACHMENT

Upper attachment point for bands or suspension straps • Rack must be bolted down to use this option • Available in Matte Black only

	PRODUCT DIMENSIONS (L X W X H)						PRODUCT WEIGHT	
	CM			INCHES			KG	LBS
XR35	15.5	2.5	20.5	6	1	8	1	2



BOLT-ON SPOTTER STANDS

Step-up platform used for assisting in heavy lifts • Requires additional lead-time • Available in Ridge Black only

	PRODUCT DIMENSIONS (L X W X H)						PRODUCT WEIGHT	
	CM			INCHES			KG	LBS
DOPT45S	36	72	16	14	28	6	17.3	38



42" MEDICINE BALL SHELF

Medicine Ball storage shelf for inside a rack • Requires XS11 or XS18 mounting brackets to connect to a rack • Available in Matte Black only

	PRODUCT DIMENSIONS (L X W X H)						PRODUCT WEIGHT	
	CM		INCHES				KG	LBS
XS01	30.5	107	8	12	42	3	8.7	19

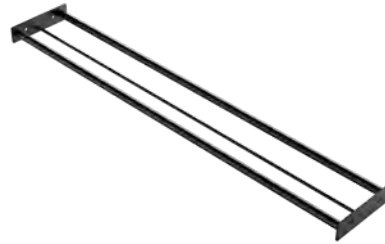

70" MEDICINE BALL SHELF

Medicine Ball storage shelf that attaches between 2 racks • Requires XS11 or XS18 mounting brackets to connect to a rack • Available in Matte Black only

	PRODUCT DIMENSIONS (L X W X H)						PRODUCT WEIGHT	
	CM		INCHES				KG	LBS
XS02	30.5	178	8	12	70	3	12.3	27

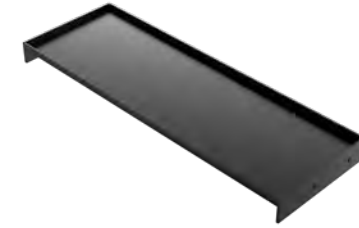

42" DB / KB SHELF

Dumbbell/Kettlebell storage shelf for inside a rack • Requires XS11 or XS18 mounting brackets to connect to a rack • Available in Matte Black only

	PRODUCT DIMENSIONS (L X W X H)						PRODUCT WEIGHT	
	CM		INCHES				KG	LBS
XS05	38.5	107	8	15	42	3	13.2	29



70" DB / KB SHELF

Dumbbell/Kettlebell storage shelf that attaches between 2 racks • Requires XS11 or XS18 mounting brackets to connect to a rack • Available in Matte Black only

	PRODUCT DIMENSIONS (L X W X H)						PRODUCT WEIGHT	
	CM		INCHES				KG	LBS
XS06	38.5	178	8	15	70	3	23.6	52



42" BUMPER / BOSU RACK

Storage rack designed to store Bumper plates or Bosu's (not for use inside a rack) • No mounting brackets required • Available in Matte Black only

	PRODUCT DIMENSIONS (L X W X H)						PRODUCT WEIGHT	
	CM		INCHES				KG	LBS
XS07	30.5	107	43.5	12	42	17	11.4	25

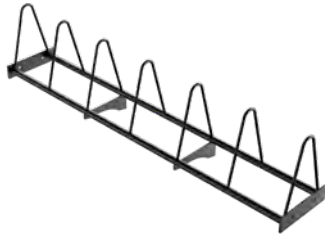

70" BUMPER / BOSU RACK

Storage rack designed to store Bumper plates or Bosu's that attaches between 2 racks • No mounting brackets required • Available in Matte Black only

	PRODUCT DIMENSIONS (L X W X H)						PRODUCT WEIGHT	
	CM			INCHES			KG	LBS
XS08	30.5	178	43.5	12	70	17	16.4	36



42" STORAGE SHELF

Extra deep shelf used for storing various accessories • For use inside a rack • Requires XS11 or XS18 mounting brackets to connect to a rack • Available in Matte Black only

	PRODUCT DIMENSIONS (L X W X H)						PRODUCT WEIGHT	
	CM			INCHES			KG	LBS
XS09	61	107	8	24	42	3	21.4	47



70" STORAGE SHELF

Extra deep shelf used for storing various accessories • Attaches between 2 racks • Requires XS11 or XS18 mounting brackets to connect to a rack • Available in Matte Black only

	PRODUCT DIMENSIONS (L X W X H)						PRODUCT WEIGHT	
	CM			INCHES			KG	LBS
XS10	61	178	8	24	70	3	31.8	70



LINEAR SHELF BRACKET

Used to connect 2 shelves out each side of a single upright • Available in Matte Black only

	PRODUCT DIMENSIONS (L X W X H)						PRODUCT WEIGHT	
	CM			INCHES			KG	LBS
XS11	20.5	8	8	8	3	3	1.9	4



SHELF MOUNTING BRACKET

Used to connect an end of a shelf to an upright • Available in Matte Black only

	PRODUCT DIMENSIONS (L X W X H)						PRODUCT WEIGHT	
	CM			INCHES			KG	LBS
XS18	20.5	8	8	8	3	3	1.9	4

MAGNUM STANDARD FRAME COLORS



Iced Silver†

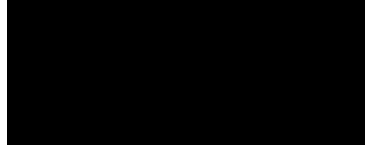

Black Glossy



Matte Black

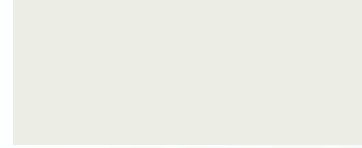

Lace White



Polarized Titanium

MAGNUM FRAME COLOR OPTIONS



Blue Streak



New Maroon



Hi-lite Yellow



Sunburst Orange



Fence Green



Blood Red

MAGNUM UPHOLSTERY COLOR OPTIONS



Black



Slate Blue



Clay Red

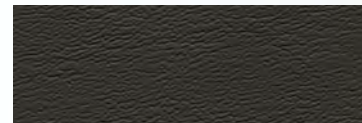

Graphite

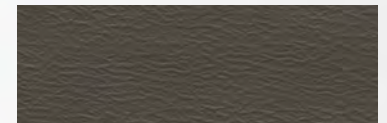

Alloy

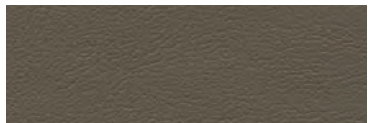

Hazelnut



American Beauty



Candy Apple



New Burgundy

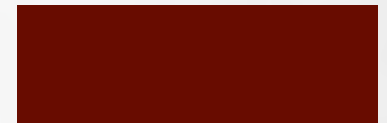

Paprika



Nasturtium



Mandarin Orange



Sun Yellow



Marigold



Emerald



Hunter Green



Royal Blue



Bluejay



New Purple



Navy



Bucksuede



Allspice



Cadet

Frame and upholstery colors applicable to the USA.
 Product pricing is reflective of **standard** upholstery only.
 Other color options available at an additional charge.
 NOTE: Actual product colors may vary from what is shown here. † Iced Silver is stocked frame color.
 Additional lead times may apply for other frame colors



VARSITY SERIES /

DESIGNED FOR SUPERIOR VALUE AND TRAINING VARIETY





VARSITY SERIES /

The Varsity Series is the ideal choice for heavy-use facilities looking for a combination of performance and value. Smart design helps you make efficient use of your space and your budget, like our versatile functional trainers and plate-loaded equipment that provide conveniently contained personal training areas. If you're looking to accommodate a steady stream of users in a limited space, look no further than the Varsity Series.



Durable Construction Built to withstand the rigorous strength training of professional sports teams. **Color-coded Adjustment Points** Conveniently located and clearly marked for easy use. **Value** Designed to handle a steady stream of users for years to come.





FUNCTIONAL TRAINER 1:2

1:2 pulley ratio provides low incremental weight changes and moderate speed work • Effective resistance 35 kg / 78 lbs. (per side) • Pulleys adjust into 17 positions to allow users to perform high-speed, low-inertia exercises • Dual-grip chin bar for greater exercise variety • Ample storage for additional optional handles

	PRODUCT DIMENSIONS (L X W X H)						PRODUCT WEIGHT		WEIGHT STACK	
	CM	INCHES		KG	LBS	KG	LBS			
VY-6044	107	180	208	42	71	82	311	686	71	156



FUNCTIONAL TRAINER 1:4

1:4 pulley ratio provides lower incremental weight changes, high speed work and increased cable travel) • Effective resistance 26 kg / 57 lbs. (per side) • Pulleys adjust into 17 positions to allow users to perform high-speed, low-inertia exercises • Dual-grip chin bar for greater exercise variety • Ample storage for additional optional handles

	PRODUCT DIMENSIONS (L X W X H)						PRODUCT WEIGHT		WEIGHT STACK	
	CM	INCHES		KG	LBS	KG	LBS			
VY-6047	107	180	208	42	71	82	376	830	103	228



3-STACK MULTI-GYM

3 weight stacks allow multiple users to exercise simultaneously • Stations include: multiple position chest / shoulder press, lat pulldown / low row, leg extension / prone leg curl

	PRODUCT DIMENSIONS (L X W X H)						PRODUCT WEIGHT		WEIGHT STACK	
	CM		INCHES				KG	LBS	KG	LBS
G1-MG30	282	323	218	111	127	86	592	1305	3 X 91	3 X 200



LEG PRESS

Oversized double-angled foot platform offers foot-placement variety • Low step-on height and oversized seat pad add comfort • Multi-position back rest adds training variety and improves hip positioning • Thick shoulder pads add comfort and improve stabilization during supine press • Starting position handle located outside the unit for easy trainer or therapist adjustment • Separate incremental adjustment for small weight increases

	PRODUCT DIMENSIONS (L X W X H)					PRODUCT WEIGHT		WEIGHT STACK		
	CM		INCHES		CM	LBS	KG	LBS		
VY-2003M	178	117	195	70	46	69	307	675	138	305

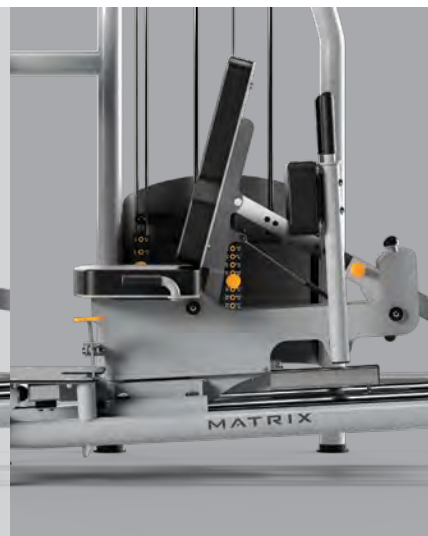



OLYMPIC FLAT BENCH

Sturdy main frame designed to provide proper positioning for spotter • Front of bench and takeoffs protected by durable guards

	PRODUCT DIMENSIONS (L X W X H)						PRODUCT WEIGHT	
	CM		INCHES				KG	LBS
VY-D78	142	122	130	56	48	51	54	120



OLYMPIC INCLINE BENCH

Sturdy main frame with large built-in spotter platform • Front of bench and takeoffs protected by durable guards

	PRODUCT DIMENSIONS (L X W X H)						PRODUCT WEIGHT	
	CM		INCHES				KG	LBS
VY-D79	155	122	152	61	48	60	82	180



FLAT BENCH

Single cross leg provides more freedom for user

	PRODUCT DIMENSIONS (L X W X H)						PRODUCT WEIGHT	
	CM		INCHES				KG	LBS
VY-D59	122	56	43.5	48	22	17	19	42



MULTI-ADJUSTABLE BENCH

Back adjusts into 5 positions: flat, 30, 45, 60 and 80 degrees • Seat adjusts into 2 positions • Handle and wheels provide easy movement • Optional VY-D85AK Kickstand allows bench to be stored vertically

	PRODUCT DIMENSIONS (L X W X H)						PRODUCT WEIGHT	
	CM		INCHES				KG	LBS
VY-D85A	147	56	48	58	22	19	43	94



MULTI-ADJUSTABLE BENCH W/ DECLINE

Backrest adjusts into 17-degree decline, flat and 6 incline positions: 15, 30, 45, 60, 67 and 80 degrees • Seat adjusts into 3 positions • Adjustable rollers hold user in position while in decline

	PRODUCT DIMENSIONS (L X W X H)						PRODUCT WEIGHT	
	CM		INCHES				KG	LBS
VY-D86	190	64	56	63	25	22	54	118



UTILITY BENCH

Simple design with footrests keeps user stable for a variety of exercises

	PRODUCT DIMENSIONS (L X W X H)						PRODUCT WEIGHT	
	CM		INCHES				KG	LBS
VY-D87	132	56	79	52	22	31	26	57



PREACHER CURL

Angled seat and arm pads keep user in proper position • Clean front design allows unit to be used as a curl stand from the front

	PRODUCT DIMENSIONS (L X W X H)						PRODUCT WEIGHT	
	CM		INCHES				KG	LBS
VY-D62	104	74	104	41	29	41	43	95



VKR W/ CHIN

Compact design allows user to perform dips, chin-ups and leg raises

	PRODUCT DIMENSIONS (L X W X H)						PRODUCT WEIGHT	
	CM		INCHES				KG	LBS
VY-D63C	135	107	244	53	42	96	109	240



BACK EXTENSION BENCH

Adjustable hip pads, stabilization handles and angled foot platform hold user in proper position

	PRODUCT DIMENSIONS (L X W X H)						PRODUCT WEIGHT	
	CM			INCHES			KG	LBS
VY-D93	124	66	94	49	26	37	39	85



ADJUSTABLE INCLINE BENCH

Easily adjusts to 6 positions from 0 to 75 degrees • Seat pad position is fixed at 15 degrees • Integrated wheels for easy transport

	PRODUCT DIMENSIONS (L X W X H)						PRODUCT WEIGHT	
	CM			INCHES			KG	LBS
G1-FW153	154	61	47	61	24	19	41	90



ADJUSTABLE DECLINE BENCH

Split, angled pad design with leg pads positions the user comfortably for decline exercises and abdominal work • Available angles in degrees: 10, 13, 15, 17, 19, 21, 23, 25 and 28

	PRODUCT DIMENSIONS (L X W X H)						PRODUCT WEIGHT	
	CM			INCHES			KG	LBS
VY-D61	152	64	79	60	25	31	44	96



ADJUSTABLE AB BENCH

Split-pad design and double-adjustable leg pads hold any size user in proper position • Handle is mounted on front rollers, providing easy exit

	PRODUCT DIMENSIONS (L X W X H)						PRODUCT WEIGHT	
	CM			INCHES			KG	LBS
VY-D77	147	56	114	58	22	45	44	97



HORIZONTAL PLATE RACK

Holds up to (8) 45-lb. bumper plates 38 cm / 15" off the floor • Space between rungs is 11.4 cm / 4.5"

	PRODUCT DIMENSIONS (L X W X H)						PRODUCT WEIGHT	
	CM			INCHES			KG	LBS
VY-D306	122	43	58	48	17	23	25	55



FLAT-TO-INCLINE BENCH

Locking rods for attachment to Power Rack docking station • Spring pin adjustment for horizontal length • 4 positions- flat, 30, 45 and 80 degrees • Handle and integrated wheels for easy movement

	PRODUCT DIMENSIONS (L X W X H)						PRODUCT WEIGHT	
	CM			INCHES			KG	LBS
VY-D695	135	79	51	53	31	20	64	140



GLUTE HAM BENCH

Handles for reverse hypers provide dual movement • Fore / aft and vertical adjustment accommodate all user sizes

	PRODUCT DIMENSIONS (L X W X H)					PRODUCT WEIGHT		
	CM	INCHES			KG	LBS		
VY-D96	140	76	127	55	30	50	79	175



WEIGHT TREE

Made of 5.1 x 5.1 cm / 2" x 2" tubing, featuring 5 weight-storage horns

	PRODUCT DIMENSIONS (L X W X H)					PRODUCT WEIGHT		
	CM	INCHES			KG	LBS		
VY-D67C	64	51	99	25	20	39	17	38

WEIGHT TREE W/ OLYMPIC BAR HOLDERS

Made of 5.1 x 5.1 cm / 2" x 2" tubing, featuring 6 weight-storage horns and 2 bar-storage tubes



	PRODUCT DIMENSIONS (L X W X H)					PRODUCT WEIGHT		
	CM	INCHES			KG	LBS		
VY-D67H	79	61	122	31	24	48	29	63



BARBELL RACK

2-sided horizontal set bar rack • Holds 10 straight or E-Z Curl bars • Integrated band or accessory storage hooks
 • Durable bar protection take-offs

	PRODUCT DIMENSIONS (L X W X H)					PRODUCT WEIGHT		
	CM	INCHES			KG	LBS		
VY-D68	145	76	168	57	30	66	57	125



2-TIER DUMBBELL RACK

2-tier, 10-pair rack ideal for pro-style dumbbells • Holds different weights of pro-style dumbbells without cradles:
 a) 2.3-22.7 kg / 5-50 lbs. or b) 25-45 kg / 55-100 lbs.

	PRODUCT DIMENSIONS (L X W X H)					PRODUCT WEIGHT		
	CM	INCHES			KG	LBS		
VY-D70	58	234	81	23	92	32	84	186



2-TIER HEX DUMBBELL RACK

2-tier rack holds 13 pairs of rubber hex dumbbells weighing 1.4-22.7 kg / 3-50 lbs.

	PRODUCT DIMENSIONS (L X W X H)					PRODUCT WEIGHT		
	CM	INCHES			KG	LBS		
VY-D697	58	234	81	23	92	32	72	158



ANGLED SMITH MACHINE

Olympic bar is counterbalanced to 11.8 kg / 26 lbs. • Olympic bar is mounted on linear bearings and shaft at a 7-degree angle • Open-ended frame design provides easy access • Flip in and out adjustable stops • 12 integrated weight-storage horns

	PRODUCT DIMENSIONS (L X W X H)						PRODUCT WEIGHT	
	CM			INCHES			KG	LBS
	CM	INCHES	CM	INCHES	CM	INCHES	KG	LBS
VY-M49	107	218	211	42	86	83	186	410



SMITH MACHINE

Bar travel limited to 72 cm / 28.5" from the floor • 6 integrated weight-storage horns • Adjustable stops flip in and out for easy access

	PRODUCT DIMENSIONS (L X W X H)						PRODUCT WEIGHT	
	CM			INCHES			KG	LBS
	CM	INCHES	CM	INCHES	CM	INCHES	KG	LBS
G1-FW161	205	141	229	80.5	55.5	90	135	297

Weight plates are not included.



PERFECT SQUAT

Large, angled, heavy-duty footplate adds stability • Adjustable starting position allows user to set pad height for squats or standing calf raises • Shoulder pads maintain parallel position to floor throughout full range of motion • 2 integrated weight-storage horns • Ideal for squats, calf work and reverse lunges

	PRODUCT DIMENSIONS (L X W X H)						PRODUCT WEIGHT	
	CM			INCHES			KG	LBS
	CM	INCHES	CM	INCHES	CM	INCHES	KG	LBS
VY-400	157	84	168	62	33	66	147	325



LEG EXTENSION

Self-adjusting tibia pad enhances comfort • Back pad is adjustable from the seated position for proper alignment • 2 integrated weight-storage horns

	PRODUCT DIMENSIONS (L X W X H)						PRODUCT WEIGHT	
	CM			INCHES			KG	LBS
VY-401	102	157	117	40	62	46	91	200



PRONE LEG CURL

Divergent angle of lower-leg pad eliminates lower-back stress • Neutral position handgrips enhance comfort and stability

	PRODUCT DIMENSIONS (L X W X H)						PRODUCT WEIGHT	
	CM			INCHES			KG	LBS
VY-402	173	91	72	68	36	30	91	200



BICEPS CURL

Side arm pads encourage proper user positioning • 1 integrated weight-storage horn • Counterbalanced exercise arm offers optimal resistance

	PRODUCT DIMENSIONS (L X W X H)						PRODUCT WEIGHT	
	CM			INCHES			KG	LBS
VY-431	97	107	112	38	42	44	68	150



TRICEPS EXTENSION

Adjustable knee pads help stabilize user during exercise • Side arm pads encourage proper positioning • 1 integrated weight-storage horn • Counterbalanced exercise arm offers optimal resistance

	PRODUCT DIMENSIONS (L X W X H)						PRODUCT WEIGHT	
	CM			INCHES			KG	LBS
VY-432	97	107	140	38	42	55	68	150



VARSITY STANDARD FRAME COLORS



Iced Silver†



Black Glossy



Matte Black



Lace White



Polarized Titanium

VARSITY FRAME COLOR OPTIONS



Blue Streak



New Maroon



Hi-lite Yellow



Sunburst Orange



Fence Green



Blood Red

VARSITY UPHOLSTERY COLOR OPTIONS

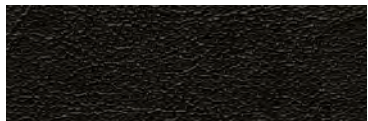

Black



Slate Blue



Clay Red

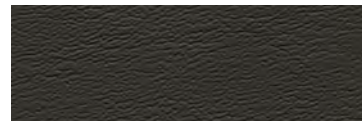

Graphite

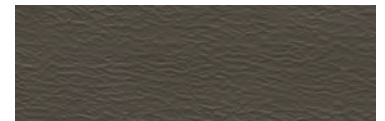

Alloy

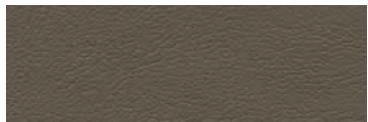

Hazelnut



American Beauty



Candy Apple



New Burgundy



Paprika



Nasturtium



Mandarin Orange



Sun Yellow



Marigold



Emerald



Hunter Green



Royal Blue



Bluejay



New Purple



Navy



Bucksuede



Allspice



Cadet

Frame and upholstery colors applicable to the USA.
 Product pricing is reflective of **standard** upholstery only.
 Other color options available at an additional charge.
 NOTE: Actual product colors may vary from what is shown here.† Iced Silver is stocked frame color.
 Additional lead times may apply for other frame colors



A TRULY GLOBAL COMPANY



AUSTRALIA / NEW ZEALAND

Johnson Health Tech Australia Pty. Ltd.

BRAZIL

Johnson Health Tech Brasil

CANADA

Johnson Health Tech Canada

CHINA

Johnson Health Tech (Shanghai) Co., Ltd.

CZECH REPUBLIC / SLOVAKIA

Johnson Health Tech CZ & SK a.s.

DENMARK

Johnson Health Tech Denmark ApS

FRANCE

Johnson Health Tech France

GERMANY / AUSTRIA

Johnson Health Tech GmbH

GREECE / BULGARIA / CYPRUS

Johnson Health Tech Hellas SA

HONG KONG

Johnson Health Tech Hong Kong

ITALY

Johnson Health Tech Italia Spa

JAPAN

Johnson Health Tech Japan

KOREA

Johnson Health Tech Co., Ltd. Korea

MALAYSIA

Johnson Fitness (Malaysia) SDN. BHD.

MEXICO

Johnson Health Tech Mexico

NETHERLANDS / BELGIUM / LUXEMBOURG

Matrix Fitness Benelux

PHILIPPINES

Johnson Health Tech Philippines Inc.

POLAND

Johnson Health Tech Sp. Z. O. O.

ROMANIA

Johnson Health Tech Romania

RUSSIA

Johnson Health Tech Russia

SPAIN / PORTUGAL

Johnson Health Tech Ibérica SL

SWITZERLAND

Johnson Health Tech (Schweiz) GmbH

TAIWAN

Johnson Health Tech Taiwan

THAILAND / CAMBODIA / LAOS / MYANMAR

Johnson Health Tech (Thailand) Co., Ltd.

UNITED ARAB EMIRATES / SAUDI ARABIA / KUWAIT / QATAR / OMAN / JORDAN

Johnson Health Tech Middle East

UNITED KINGDOM

Johnson Health Tech UK Ltd.

UNITED STATES

Johnson Health Tech North America

VIETNAM

Johnson Health Tech (Vietnam) Co. Ltd.

Visit matrixfitness.com for full contact information.

MATRIX



ABOUT MATRIX FITNESS

In 2001, Johnson Health Tech established Matrix Fitness to bring premium fitness equipment to the marketplace. Since then, we've become the fastest-growing commercial fitness equipment brand in the world. Matrix has leveraged continuous innovation and cross-cultural collaboration to emerge as an industry vanguard, constantly challenging standards and raising expectations for fitness equipment design and exercise technology.



Our product portfolio has expanded to over 500 products including strength equipment, cardio platforms, group exercise modalities, athletic performance training tools, fitness technology, integrated HIIT workouts, turnkey programming and much more. With over 30 subsidiaries around the world, Matrix is uniquely equipped to meet fitness and wellness needs in every corner of the globe.

Today, Matrix Fitness is dedicated to serving fitness facilities of all kinds, setting them apart in ways that attract and retain more members. Our mission is to delight and excite our customers through complete solutions and committed partnership provided by a world-class organization.

MATRIX
Strong • Smart • Beautiful

Matrix Fitness

1600 Landmark Drive
Cottage Grove, WI 53527 USA

   matrixfitnessusa
matrixfitness.com | 866.693.4863

©2021 Matrix Fitness. All Rights Reserved.

AUTHORIZED MATRIX FITNESS DISTRIBUTOR

